

# *Britony*

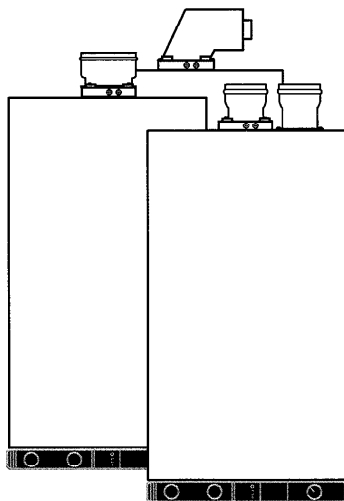

Combi 80

Combi 100

## COMBINATION BOILER

Heating and Instantaneous Domestic Hot Water

Fanned Flue system

## Installation and Operating instructions

Chaffoteaux  
et Maury



These instructions are suitable for the following boilers :

Britony Combi 80  
Britony Combi 100

## CUSTOMER CARE

Chaffoteaux et Maury Ltd., as a leading manufacturer of domestic and commercial water heating appliances, is committed to providing high quality products and a high quality after sales service. If it is necessary to contact an engineer, then telephone your local Chaffoteaux Service Centre. The number can be obtained from the leaflet enclosed in the customer care pack with your boiler or by telephoning the Chaffoteaux Customer Services Department at Telford.

Advice on installation or servicing can also be obtained by contacting the Chaffoteaux Customer Services Department at Telford.

### CUSTOMER SERVICES DEPARTMENT

Tel: 01952 222288

Fax: 01952 260915

## GUARANTEE

The manufacturer's guarantee is for 12 months from the date of purchase. The guarantee is voidable if the appliance is not installed in accordance with the recommendations made herein or in a manner not approved by the manufacturer. To assist us in providing you with an efficient after sales service, please return the guarantee registration card enclosed with the boiler without delay.

## STATUTORY REQUIREMENTS

The installation of this appliance must be carried out by a CORGI Registered person or other competent person and in accordance with the requirements of the Gas Safety (Installation and Use) Regulations.

In addition, the installation must also comply with the current byelaws of Local Water Undertakings, Building Regulations, IEE Wiring Regulations, Local Authority Building Standards (Scotland) Regulations and the Safety Document 635 The Electricity at work Regulation. It should also be carried out in accordance with current editions of the following British Standards Codes of practice: BS 6891, BS 5440 parts 1 and 2, BS 5449 part 1, BS 7593, BS 6798, BS 5546, BS 4814, BS 7074 part 1 and 2, BS 7671 and BG DM2.

If there is a possibility of the incoming mains water pressure exceeding 10 bar then a suitable pressure limiting valve must be fitted.

To comply with the Control of Substances Harmful to Health Regulation 1988 we are required to provide information on the following substance that is contained within the appliance.

Description: Combustion Chamber Lining

Material: Alumino Silicone Fibre

Precautions: During servicing, keep the dust generation to a minimum and avoid inhaling any dust and contact with the skin and eyes. Normal handling and use will not present any discomfort, although some people with a history of skin complaints may be susceptible to irritation. When disposing of the lining, ensure that it is securely wrapped and wash hands after contact.

# Contents

	<b>Page</b>		
CUSTOMER CARE .....	3	INSTALLING THE BOILER .....	19
Guarantee .....	3	Installation .....	19
Statutory Requirements .....	3	Fitting the horizontal flue .....	20
Contents .....	4	Making the electrical connections .....	22
INTRODUCTION .....	5	COMMISSIONING AND TESTING .....	24
DESCRIPTION .....	6	Pre-commissioning .....	24
Location of components .....	6	Domestic Hot Water .....	24
TECHNICAL DATA .....	8	Central Heating .....	24
DIMENSIONS .....	10	Lighting the boiler .....	24
OPERATION .....	12	Post Commissioning .....	25
Domestic Hot Water Mode .....	12	Handing over to the Householder .....	25
Central Heating Mode .....	12	USER'S INSTRUCTIONS .....	26
INSTALLATION REQUIREMENTS .....	14	Control panel .....	26
Location .....	14	Isolating taps .....	26
Flue .....	14	Switching on .....	27
Ventilation .....	15	Hot water .....	27
Gas Supply .....	15	Heating and hot water .....	27
Electrical Supply .....	15	Turn off the boiler .....	27
SYSTEM GUIDANCE .....	16	INSTRUCTION FOR SETTING THE BUILT	
Showers .....	16	IN CLOCK .....	28
Flushing and Water Treatment .....	16	Mechanical programmer .....	28
System Controls .....	16	Electronic programmer .....	29
Bypass and pump .....	17		
Expansion Vessel .....	18		
Filling Point .....	18		

# 1 - Introduction

The BRITONY COMBI is a fully automatic, wall mounted, low water content combination boiler. It is a room sealed, fan assisted, balanced flued appliance providing central heating and mains pressure domestic hot water on demand. It has electronic ignition and is suitable for all modern electrical control systems. The boiler is designed for sealed systems only and a circulating pump, expansion vessel together with a pressure gauge and safety valve are included within the boiler.

The standard horizontal flue kit is suitable for lengths 300 mm minimum to 610 mm maximum and includes an elbow adapter that can be rotated through 360°. The horizontal flue can extend up to 3 metres using 1 metre flue extension kits. 45° and 90° flue bends are also available as accessories.

The BRITONY COMBI is also suitable for concentric vertical flueing and twin pipes. Adapters and accessories are available.

The boiler is packed in two cartons:

1. the boiler
2. the flue assembly and the pre installation kit

## 2 - Description

### Location of components

1. Air pressure switch
2. Steel chassis complete with expansion vessel
3. Main heat exchanger
4. Combustion chamber
5. Multi- gas burner assembly comprising ignition and ionisation electrodes
6. Automatic air separator and automatic vent
7. Heating circuit flow switch
8. Pump
9. Electrical box
10. DHW circuit flow switch
11. Overheat thermostat
12. Gas valve assembly
13. Sealed chamber
14. Flue hood with fan
15. Hot water control thermistor
16. Central heating control thermistor
17. Three way valve
18. CH Flow isolating valve
19. Three position Selector switch
20. User's instruction panel.
21. Heating flow temperature adjustment
22. Green indicator - Power ON

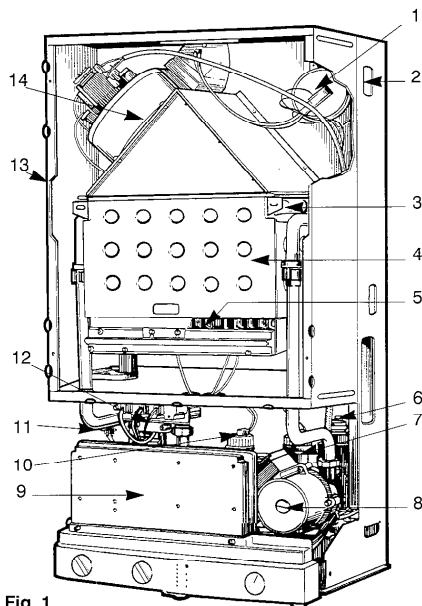
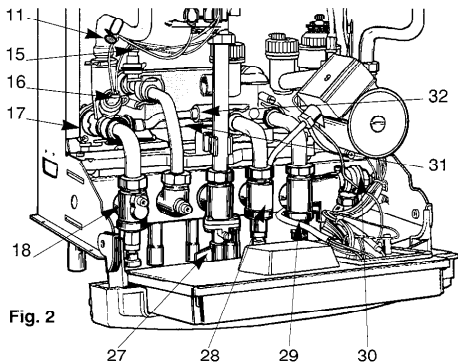

Fig. 1



# Description (continued)



- 23. Orange indicator - Burner ON
- 24. Red indicator - Lock out / flame failure
- 25. Reset button
- 26. Pressure gauge
- 27. Gas service tap
- 28. Water service tap
- 29. CH Return isolating valve
- 30. Pressure relief valve

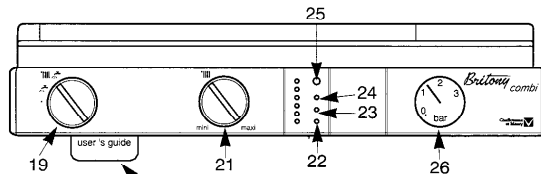
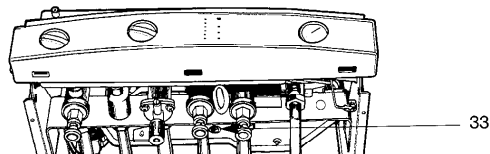

Fig. 3



- 31. Secondary heat exchanger
- 32. By pass
- 33. By pass adjustment screw

# 3 - Technical data

Britony combi type	80	100
Appliance category .....	Cat II <sub>2H 3+</sub>	Cat II <sub>2H 3+</sub>
<b>Heat input C/H &amp; DHW</b>		
Maximum in kW .....	28.7	31.1
Maximum in Btu/h .....	97946	106133
<b>Heat output C/H &amp; DHW</b>		
Maximum in kW .....	23.25	28.2
Maximum in Btu/h .....	79347	96236
<b>C/H circuit pressures</b>		
Min operating in bar	0.7	0.7
in lb/in <sup>2</sup>	10	10
Max operating in bar	2.5	2.5
in lb/in <sup>2</sup>	36.3	36.3
<b>DHW flow rates</b>		
@ 30°C in l/min .....	11.1	13.4
in gal/min .....	2.45	2.95
@ 35°C in l/min .....	9.54	11.48
in gal/min .....	2.10	2.53
<b>DHW circuit pressures</b>		
Min operating in bar	0.1	0.1
in lb/in <sup>2</sup> .....	1.45	1.45
Max operating in bar	10	10
in lb/in <sup>2</sup> .....	145	145
Flow limiter rate in l/min	10	12

Britony combi type	80	100
<b>Natural gas G20</b>		
<b>Gas rate</b>		
Maximum in m <sup>3</sup> /h .....	2.74	3.34
Maximum in ft <sup>3</sup> /h .....	97	118
<b>Inlet pressure</b>		
Nominal in mbar .....	20	20
Nominal in in wg .....	8	8
<b>Burner pressure</b>		
Nominal in mbar .....	11	12.8
Nominal in in wg .....	4.4	5.12
<b>Burner injector diameter</b>		
Natural gas G20 in mm	1.23	1.26
<b>PROPANE L.P.G. G31</b>		
<b>Gas rate</b>		
Maximum in kg/h .....	2.00	2.42
Maximum in ft <sup>3</sup> /h .....	4.41	5.34
<b>Inlet pressure</b>		
Nominal in mbar .....	37	37
Nominal in in wg .....	14.8	14.8
<b>Burner pressure</b>		
Nominal in mbar .....	35	30.4
Nominal in in wg .....	14	12.16



# Technical data (continued)

Britony combi type	80	100	Britony combi type	80	100
<b>BUTANE L.P.G. G30</b>					
<b>Gas rate</b>			<b>Safety discharge</b>		
Maximum in kg/h .....	2.04	2.45	in bar .....	3	3
Maximum in Lbs/h .....	4.50	5.40	in lb/in <sup>2</sup> .....	43.5	43.5
<b>Inlet pressure</b>			<b>Expansion vessel</b>		
Nominal in mbar .....	28	28	Pre-charge pressure in bar ..	0.7	0.7
Nominal in in wg .....	11.2	11.2	Pre-charge pressure in lb/in <sup>2</sup>	9.4	9.4
<b>Burner pressure</b>			Net capacity at 3 bar in liter	5.44	5.44
Nominal in mbar .....	26,7	24	<b>Adjustable by-pass</b>		
Nominal in in wg .....	10,7	9.6	Minimum flow rate in l/h ...	100	100
<b>Burner injector diameter</b>			Minimum flow rate in gal/min	0.36	0.36
LPG G30 and G31 in mm ..	0.72	0.76	Maximum flow rate in l/h ...	700	700
<b>Burner injector diameter</b>			Maximum flow rate in gal/min	2.56	2.56
LPG G30 and G31 in mm ..	0.72	0.76	<b>Electrical characteristics</b>		
<b>Compartment ventilation</b>	n o t r e q u i r e d		Supply .....	230 v	50 Hz
			Consumption .....	150 w	150 w
			Protection .....	IP 44	IP 44
			Fuse n°1 .....	2 A	2 A
			Fuse n°2 .....	1.25 A	1.25 A
			External controls .....	24 v	24 v

# 4 - Dimensions

## Weights

### With packaging :

-Britony combi 80 :	44.2kg
-Britony combi 100 :	45.2 kg

### Without packaging :

-Britony combi 80 :	42.2kg
-Britony combi 100 :	43.2 kg

### Lift weight :

-Britony combi 80 :	36.2 kg
-Britony combi 100 :	37.2 kg

## Tails diameter

<b>I</b>	Safety valve outlet	Ø 15 mm
<b>J</b>	Heating flow	Ø 22 mm
<b>K</b>	D.H.W. flow	Ø 15 mm
<b>L</b>	Gas supply	Ø 22 mm
<b>M</b>	Cold water inlet	Ø 15 mm
<b>N</b>	Heating return	Ø 22 mm

## Outer case dimensions :

- Width :	440 (minimum space required 450)
- Height :	850
- Depth :	380

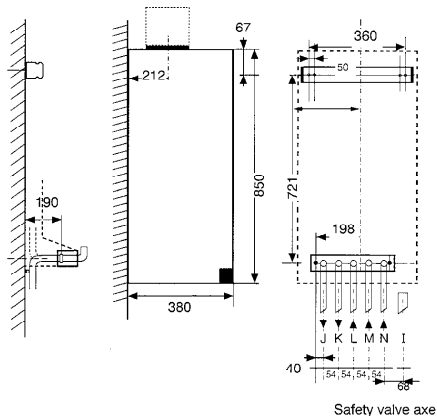

Fig. 4

# Dimensions (continued)

## Minimum clearances :

- Both sides 5 mm
- Above casing 170 mm
- Below casing 200 mm
- Front ( for servicing) 500 mm
- Front (in operation) 5 mm

The boiler is suitable for the 3 flue types :

- type C 12 C 22 or C 42
- type C 32 xx or C 32 xy

TYPE C12 or C42

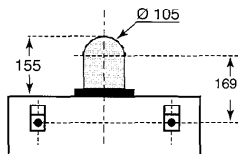

TYPE C32 xx

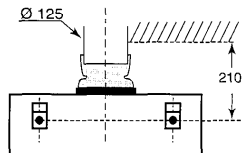

TYPE C32 xy

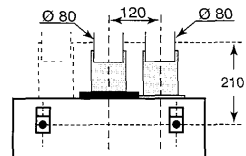



Fig. 5 Sizes in mm





# 5 - Operation

## Domestic Hot Water Mode

To be able to supply hot water, the selector switch 19 Fig. 6 must be in either on  or  position. This will be

confirmed by the green indicator light  22 Fig. 6

When a tap or shower is turned on, the flow of mains water, above 2 litres per min., will activate the DHW flow switch 10 Fig 7 and allow the 3 way valve 17 Fig. 7 to move to the DHW position. The pump can now circulate primary water heated by the main heat exchanger through the secondary heat exchanger.

The first stage solenoid 12a Fig. 7 and safety solenoid 12c Fig. 7 open together to allow gas to the burner. The ignition sequence begins and a continuous high speed spark ignites the gas. As soon as a flame is detected the orange indicator bulb  23 Fig. 6 will light and the second stage solenoid 12b Fig. 7 opens to allow the full gas rate. If a flame is not detected, after 8 seconds, the security solenoid closes and shuts off the gas. The red lockout indicator bulb  24 Fig. 6 will light. The domestic hot water temperature is controlled by the hot water control thermistor 15 Fig. 7 and the central heating control thermistor 16 Fig. 7. This system anticipates the changes of temperature in the secondary heat exchanger

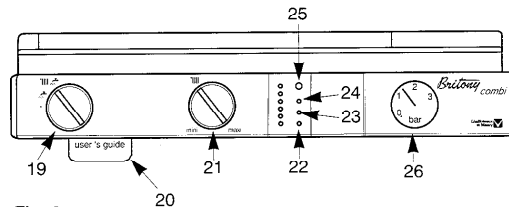





Fig. 6

and ensures accurate temperature regulation.

When the tap is closed the burner is extinguished and the pump stops. The boiler will now stay in the hot water mode for three minutes to maintain temperature to ensure a fast response in the event of a subsequent hot water demand.

Priority will be given to a demand for hot water. This will interrupt the central heating for the duration of hot water delivery.

## Central Heating Mode

To be able to supply hot water, the selector switch 19 Fig. 6 must be in either on  or  position. This will be confirmed by the green indicator light  22 Fig. 6

# Operation (continued)

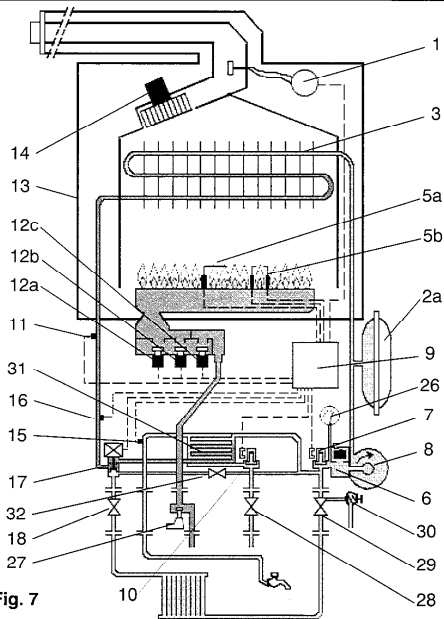

Fig. 7

When there is a demand for heating (either from the room thermostat or the clock) and the boiler temperature control is calling for heat. The pump starts and at a flow rate of 4 ltr/min the central heating flow switch operates allowing the ignition sequence to begin. The first stage solenoid 12a Fig. 7 and safety solenoid 12c Fig. 7 open together to allow gas to the burner. The ignition sequence begins and a continuous high speed spark ignites the gas. As soon as a flame is detected the orange indicator bulb 23 Fig. 6 will light. After 45 seconds the second stage solenoid 12b Fig. 7 opens to allow the full gas rate. If a flame is not detected, after 8 seconds, the safety solenoid closes and shuts off the gas. The red lockout indicator bulb 24 Fig. 6 will light.

The central heating flow temperature is controlled by the central heating control thermistor 16 Fig. 7. The boiler has been designed to minimise cycling and will not attempt to relight for at least 3 minutes after the boiler thermostat has been satisfied. When the room thermostat is satisfied the burner will switch off and the pump will remain running for a further 3 minutes before it to stops.

## NB

It is possible to override the 3 minute delay by pressing the RESET button 25 Fig. 6.



# 6 - Installation requirements

## Location

The boiler can be installed on any suitable internal wall. Provision must be made to allow the correct routing of the flue and siting of the terminal to allow the safe and efficient removal of the flue products. The appliance may be installed in any room, although reference must be made to the IEE regulations if it contains a bath or shower. A compartment or cupboard may be used provided that it has been purpose-built or modified for the purpose. Provision must be made for permanent ventilation. Detailed recommendations are given in BS 5440 pt 2. If it is proposed that it is installed in a timber framed building then reference must be made to British Gas Document DM2, or advice sought from CORGI.

## Flue

The boiler must be installed so that the flue terminal is exposed to the free passage of external air at all times. It must not be allowed to discharge into another room or space such as an outhouse or closed lean-to. The minimum acceptable clearances are shown below:

- |  |        |
|--|--------|
| - A Directly below an opening, window, etc   | 300 mm |
| - B Below gutters soils pipes or drain pipes | 75 mm  |
| - C Below eaves                              | 200mm  |
| - D Below balconies or car port roof         | 200 mm |
| - E From a vertical drain pipe or soil pipe  | 75 mm  |

- |   |         |
|---|---------|
| - F From an internal or external corner                     | 300 mm  |
| - G Above ground roof or balcony level                      | 300 mm  |
| - H From a surface facing the terminal                      | 600 mm  |
| - I From another terminal facing the terminal               | 600 mm  |
| - J From an opening into the dwelling when under a car port | 1200 mm |
| - K Vertically from a terminal on the same wall             | 1500 mm |
| - L Horizontally from a terminal on the same wall           | 300 mm  |
| - M fixed by the flat roof ubbink rolux 4GM flue terminal   |         |
| - N fixed by a pitched roof ubbink rolux 4GM flue terminal  |         |

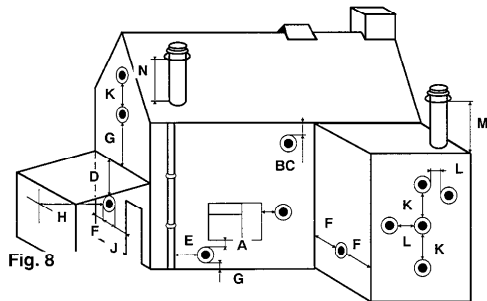

Fig. 8

# Installation requirements (continued)

It may be necessary to protect the terminal with a guard if it is accessible and could be damaged. Reference should be made to the Building Regulations for guidance. Suitable guards may be obtained from the following manufacturer:

Quinnel Barret & Quinnel Wireworks  
Old Kent Road  
London SE15 1NL  
Tel: 0171 639 1357

## Ventilation

The room in which the boiler is installed does not require specific ventilation. **IF IT IS INSTALLED IN A CUPBOARD OR COMPARTMENT PERMANENT VENTILATION IS NOT REQUIRED FOR COOLING PURPOSES.** If vents are installed, they must communicate with the same room or be on the same wall to outside air.

outside air.

## Gas Supply

The gas installation and soundness testing must be in accordance with the requirements of BS 6891. The boiler requires: 2.74 m<sup>3</sup>/hr and a 22 mm supply. Ensure that the pipe size is adequate for the demand including other gas appliances on the same supply.

## Electrical Supply

The appliance requires an earthed 230V - 50 Hz supply and must be in accordance with current I.E.E. It must also be possible to be able to completely isolate the appliance electrically. Connection should be via a 3 amp fused double-pole isolating switch with contact separation of at least 3 mm on both poles. Alternatively, a fused 3 Amp. 3 pin plug and unswitched socket may be used, provided it is not used in a room containing a bath or shower. It should only supply the appliance.

## 6 - System guidance

The boiler is suitable for sealed systems only. The maximum working pressure for the appliance is 10 bar. All fittings and pipework connected to the appliance should be of the same standard. If there is a possibility of the incoming mains pressure exceeding 10 bar, particularly at night, then a suitable pressure limiting valve must be fitted.

The boiler is designed to provide hot water on demand to multiple outlets within the property. If there is a requirement for greater demands, for example if the property has several bathrooms and cloakrooms, a vented or unvented hot water storage system may be used.

### Showers

Any shower valves used with the appliance should be of a thermostatic or pressure balanced type. Refer to the shower manufacturer for performance guidance and suitability.

### Flushing and Water Treatment

The performance of the appliance could be impaired by system debris or the effects of corrosion. The system must be flushed thoroughly to remove metal filings, solder, machining oils and other fluxes and greases before connecting the boiler. If it is an existing system, an appropriate flushing and descaling agent should be used. Refer to BS 7593 (1992) for

guidance. For more information on the use of corrosion inhibitors, flushing and descaling agents, advice can be sought from the manufacturers of water treatment products such as:

Betz Dearbon Ltd  
Foundry Lane  
Widnes  
Cheshire  
WA8 8UD  
Tel: 0151 424 5351

Fernox Manufacturing  
Britannica Works  
Clavering  
Essex  
CB11 4QZ  
Tel: 01799 550811

### System Controls

The boiler is electrically controlled and is suitable for most modern electronic time and temperature controls. The addition of such external controls can be beneficial to the efficient operation of the system. The boiler connections for external controls are 24V and so only controls of 24V or that have voltage free contacts should be used.



# System guidance (continued)

## By pass and Pump

The boiler is fitted with a pre-adjusted by pass. Although adjustment is not normally necessary, the by pass can be reset by turning screw ( D Fig. 9 ) anticlockwise to open the by-pass using the chart below for guidance.

If used on a system with thermostatic radiator valves, the flow rate with the thermostatic valves closed should be adjusted to at least 100 l/hr. The chart below indicates the residual head of the pump available for the system.

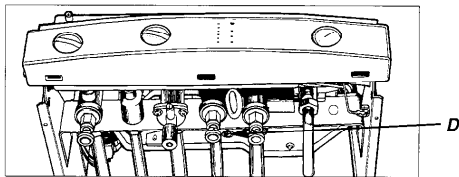

Fig. 9

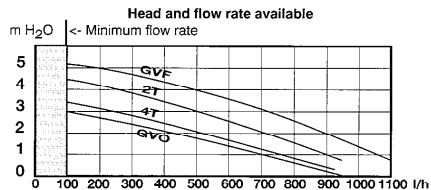

Fig. 10



# System guidance (continued)

## Expansion Vessel

The expansion vessel is pre-charged to 0.7 bar (10 lb/in<sup>2</sup>). The vessel is suitable for systems up to 145 litres capacity. For systems of greater capacity an additional expansion vessel will be required. Refer to the chart below and BS 7074 pt 1 or BS 5449.

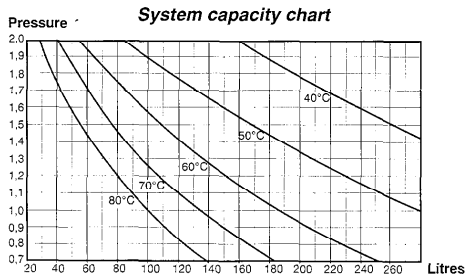

Fig. 11

## Filling Point

Provision must be made to be able to charge the system on commissioning and to make up any subsequent pressure loss. The method of connection must utilise approved equipment and must comply with the water regulations. A filling loop can be so installed as to be hidden beneath the boiler.

Fig. 12

## 7 - Installing the boiler

Please check that you are familiar with the installation requirements before commencing work.(section 6)

### Installation

The installation kit included with the flue components comprise following items :

- Hanging bracket
- A paper template (showing the dimensions of the boiler with 5 mm side clearances, fitting instructions and commissioning instructions)
- Connection tails
- Screws and wall plugs
- Connection washers and filters
- Pre-piping jig
- Installation manual

*Method of positioning the boiler on the wall.*

The paper template can be used to ensure the correct positioning of kitchen cabinets etc. It also details the commissioning instructions.

The paper template has to be fixed to the wall and used to fix the position of the hanging bracket, the centre for the flue hole and, if required, the fixings for the pre-piping jig.

Drill and plug the wall and secure the hanging bracket using the screws provided. Remove the boiler from its packaging as shown in Fig. 13 and remove the outer case as shown in Fig.14. Place the boiler on the wall on the hanging bracket. If required, there is space for all piping to pass behind the

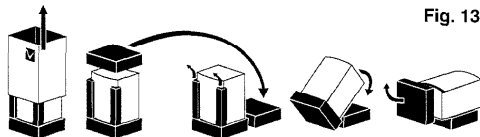

Fig. 13

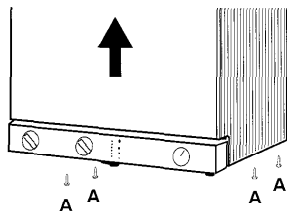
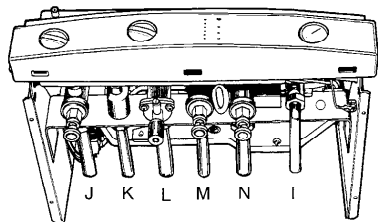

Fig. 14

## 7 - Installing the boiler (continued)

boiler. Using Fig. 15 for reference, connect the gas and water pipes to the valves located at the base of the appliance using the tails provided. There is a 190 mm space between the valves and the wall to make these connections.

Provision must be made to fill and recharge the system



I	Safety valve outlet	Ø 15 mm
J	Heating flow	Ø 22 mm
K	D.H.W. flow	Ø 15 mm
L	Gas supply	Ø 22 mm
M	Cold water inlet	Ø 15 mm
N	Heating return	Ø 22 mm

Fig. 15

pressure. This can be achieved using a filling loop or other methods approved by the local water authority.

The pressure relief should terminate below the boiler over a tundish or 22 mm pipe (see Fig. 15) which should in turn discharge safely outside the premises. Care should be taken that it does not terminate over an entrance or window or where a discharge of heated water could endanger occupants or passers by.

The system should be carefully checked for leaks, as frequent refilling could cause premature system corrosion or unnecessary scaling of the heat exchanger.

### Fitting the Horizontal Flue

The instructions for the vertical and biflux (twin pipe) flue options are included with the relevant adaptor kits.

The standard flue supplied with the appliance is suitable for lengths from 300 mm minimum to 610 mm maximum. This means for rear flueing, the standard kit will accommodate a maximum wall thickness of 490 mm, and for side flueing a maximum wall thickness of 477 mm. This takes into account the minimum appliance side clearances of 5 mm.

If the fixing is a rear exit flue, the template provides the position of the centre for drilling the flue hole with a core drill.

If the flue is a side exit installation then calculate the position of the hole with a slope of 5 mm / metre to the outlet.

## 7 - Installing the boiler (continued)

Connection of the boiler to the system.

- Hinge down the electrical box to gain access to the valves connections. Push in the tabs (P Fig 19) on either side of the boiler and pivot the box forward.
  - Remove the yellow caps from connecting pipes and connect the boiler to the taps using gaskets provided in the plastic bag.
- Washer "R" for gas connection.  
Filter "F" for cold water inlet

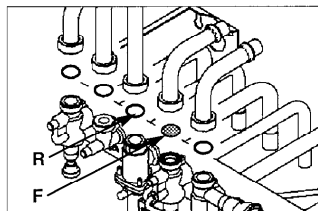

Fig 16

## 7 - Installing the boiler (continued)

### Making the Electrical Connections

Hinge down the electrical box to gain access to the electrical connections. Push in the tabs (P Fig 19) on either side of the boiler and pivot the box forward.

Undo the two retaining screws, remove cover and remove cable clamp. (A Fig 19)

Connect the live and neutral wires to the multipin plug leaving sufficient earth wire to connect to the earthing point. (B Fig 20) Note: The connections should be made so that should the lead be pulled from its anchorage, the current carrying wires become taut before the earth wire.

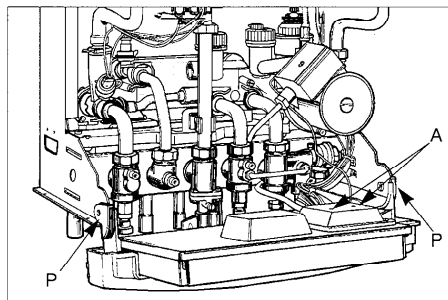
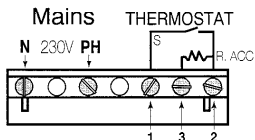

Fig. 19

# Installing the boiler (continued)



connector **C**

Fig. 20

If using a room thermostat or other external control, they can be connected in place of the link on the multipin plug. (fig 21)  
**Note: Use only controls designed for voltage free switching or 24V supply.**

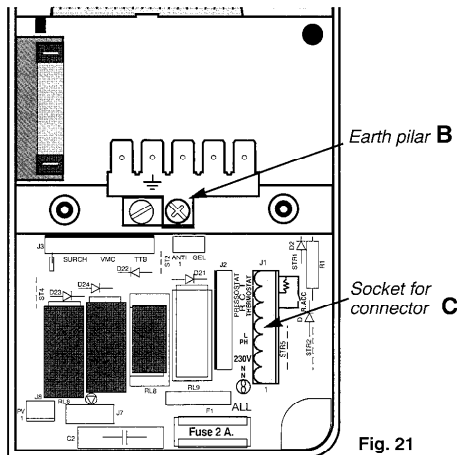

Fig. 21

Connect multipin plug onto into the socket on the power board. Secure the cable using the cable clamp and replace the cover. To prevent damage, the cable should then be routed through the cable support on the right hand side of the chassis.

# 8 - Commissioning and testing

## Pre-commissioning

Ensure that the system has been adequately flushed.  
Purge gas supply of air and test for soundness.  
Carry out final electrical tests to ensure the correct polarity and earthing continuity.

## DHW

Open the main cold feed valve.  
Open all hot taps to purge DHW system.  
Check for water soundness.  
Check flow rate at the bath tap is set at 11 ltr/min for a 30°C temperature rise.

## Central Heating

Open flow and return valves on the boiler.(18 and 29 Fig 22)  
Open the automatic air vent (6 Fig 23)  
Fill system and vent radiators.  
Set system pressure and remove filling loop.  
Check for leaks.  
Manually check pump is free to turn.  
Switch on electrical supply.  
Turn selector switch ( 19 Fig 23) to Winter position ( heating and hot water). 

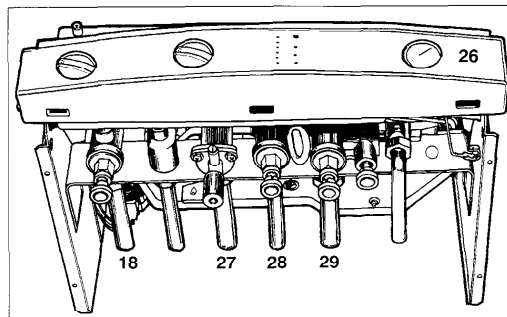

Fig. 22

Allow pump to run for several minutes.  
Isolate electrical supply.  
Drain boiler and check water filter for installation debris.  
Replace filter and recharge system.

## Lighting the Boiler

Connect gas pressure gauge to test point ( 43 Fig. 23).  
Turn on the gas supply and boiler gas tap ( 27 Fig. 22).  
Ensure electrical supply is on.  
Ensure all external controls are calling for heat.



## 8 - Commissioning and testing (continued)

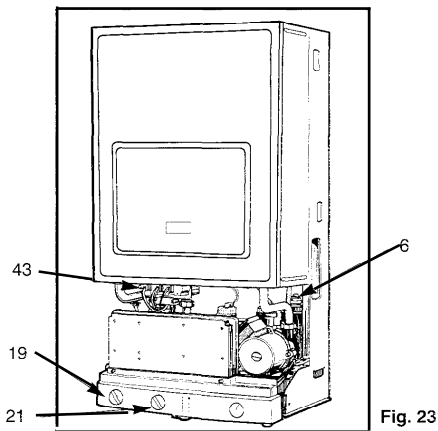



Fig. 23

Turn selector switch ( 19 Fig. 23) to Winter position ( heating and hot water). 

Turn the boiler thermostat to maximum ( 21 fig 23).

The boiler will light.

Allow the boiler to heat system.

Check that the inlet gas pressure is 20 mbar (8 in wg) with

boiler operating. (working pressure).

Check the operation of the boiler controls and safety devices.(see separate servicing leaflet for details)

Re-flush the system to remove any dissolved oils and fluxes.

Recharge system pressure and introduce any water treatment as required.

### Post Commissioning

Ensure system pressure has been set correctly.

Set boiler thermostat and controls.

Set programmer to householder's requirements.

Set external controls.

### Handing Over to the Householder

Demonstrate the lighting and operation of the boiler.

Demonstrate how to maintain the system pressure.

Demonstrate the operation and setting of the built-in programmer.

Explain the benefits of annual maintenance by a competent person.

Explain how to register guarantee.

Leave users instructions, installation manual and all other documentation with the householder.

# 9 - User's instructions

## Control panel

19. Three position Selector switch

● = Switched OFF

☀ = Hot water only

☀ ☀☀☀ = Hot water + Central heating

20. User's instruction panel.

21. ☀☀☀ Heating flow temperature adjustment

22. ○ Green indicator - Power ON

23. 🕯 Orange indicator - Burner ON

24. 🚫 Red indicator - Lock out / flame failure

25. "RESET" Reset button

26. 🕒 Pressure gauge

## Isolating Taps

18. CH Flow isolating valve

27. Gas service tap

28. Water service tap

29. CH Return isolating valve

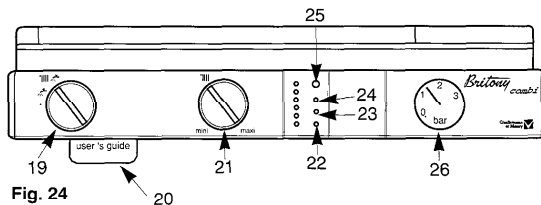

Fig. 24

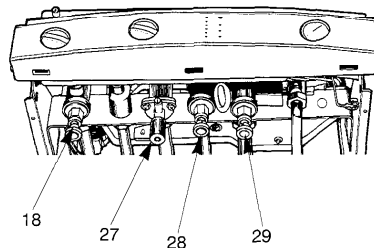





Fig. 25

# 9 - User's instructions (continued)





## Switching on

- 1) Check that the gas service tap is opened at the gasmeter and main power is on.
- 2) Check that pressure in central heating system is above 0.7 bar and below 2.5 bar with the pressure gauge (26).
- 3) Open the gas tap (27) by turning from right to left. 
- 4) The boiler is now ready to use.

## Hot Water

- 1) Turn selector switch (19) to position . The green "power on" indicator  will light.
- 2) Turn on a hot water tap, the orange "burner on" indicator  will light and the water will become hot.

## Heating and Hot Water

- 1) Turn selector switch (19) to position  . The green "power on" indicator  will light.
- 3) If the room thermostat (if fitted), the boiler temperature control  and the clock (if fitted) are all calling for heat, the orange "burner on" indicator  will

light and the heating will be on.

When there is a need for hot water while the heating is on, it is only necessary to turn on a hot tap. The heating will be interrupted momentarily while the hot water is being delivered. The boiler will switch back automatically to heating when the tap is turned off.

**Note:** If the boiler has been turned off for some time the first attempt to light it may result in a lockout . If this happens press the reset button (25) and the boiler will light.

## To Turn Boiler Off Completely

- 1) Turn the selector switch (19) to the off position .
- 2) Turn the gas tap (27) from left to right "STOP".

# Instruction for setting the built in clock

## MECHANICAL PROGRAMMER

### 1. General layout

The mechanical clock covers a 24 hour period. Each tappet represents 20 minutes (A Fig. 27). An override switch is located on the right hand side of the clock (B Fig 27).

### 2. To set the time

To set the time of day, grasp the outer edge of the dial and turn slowly clockwise until the correct time is lined up with the arrow.

### 3. To Set the "On" and "Off" times

The clock uses a 24hours system. e.g. 8 =8.00 am and 18 = 6.00 pm "ON" periods are set by sliding all tappets between the "ON" time and the "OFF" time to the outer edge of the dial. The tappets remaining at the centre of the dial are the "OFF" periods.

### 4. To select function mode

Put the selector switch (B) to Automatic to control the boiler by the clock. Put the switch (B) to ON to select permanent operation or to OFF to turn heating off permanently.

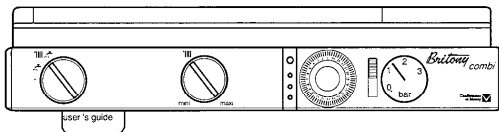

Fig. 26

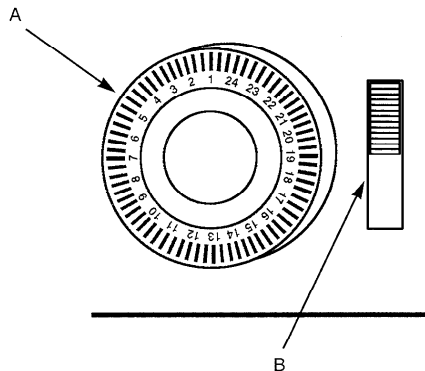

Fig. 27

# Instruction for setting the built in clock (cont.)

## ELECTRONIC PROGRAMMER

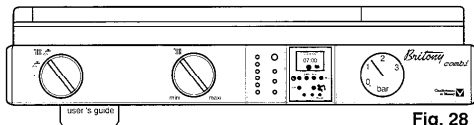
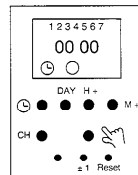
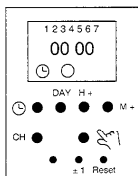

Fig. 28

### 1. General Layout

In normal use the LCD display shows the day, the time and control status. In other words whether the boiler is on or off, whether it is permanently on or permanently off or whether the override button has been pressed.



### 2. To Set the "On" and "Off" times

There is the facility for easy programming.

1. All seven days can be programmed as a block.

or

2. Monday to Friday as a block.

and then

3. Saturday and Sunday as a block

as well as

4. Changing the programme for any individual days.

It is advisable to clear the reset memory before starting. This is done by pressing the reset button for a few seconds with a pencil or similar implement. The screen will show all the symbols.



# Instruction for setting the built in clock (cont.)

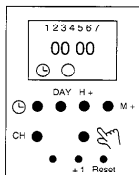

## Example 1.

The boiler switches on at the same time every day of the week.



**Step 1.** Press Reset button with a pencil or similar tool to clear the memory.

**Step 2.** Press CH button. To select display

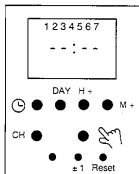
**Step 3.** Press DAY button once. Mon to Sun are displayed at the top of the screen.



**Step 4.** Press the H+ (hours) button and the M+ (minutes) button to set the first "on" time of the day.

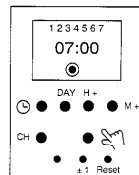

**Step 5.** Press the  button to select "Switch on" symbol 



**Step 6.** Press CH button to store in memory.

**Step 7.** Press day button to display all of the days of the week again.

**Step 8.** Press the H+ and the M+ to set the first "off" time of the day.

**Step 9.** Press on  button to select "Switch off" symbol 

**Step 10.** Press CH to store.

**Step 11.** Press day, H+, M+ and then CH for each on and off period for a single day. The whole week has now been stored.

**Step 12.** By repeatedly pressing CH each of the times entered can be viewed and checked. At this stage an individual day's times can be changed. When that day is displayed, press H+ and M+ as required.

Then it is necessary to set the current day and time. Please refer to the relevant section page 32.

# Instruction for setting the built in clock (cont.)

## Example 2

The boiler switches on at the same time Monday to Friday, but at a later time at the weekend.

**Step 1.** Press reset button with a pencil or similar tool to clear the memory and time (only if necessary). The screen will show all the symbols for a few seconds.

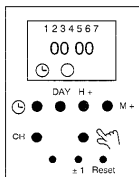

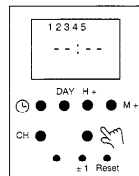

**Step 2.** Press CH button. To select display

**Step 3.** Press day button twice. Mon to Fri is displayed at the top of the screen.





**Step 4.** Press the H+ (hours) button and the M+ (minutes) button to set the first "on" time of the day.

**Step 5.** Press on  button to select "Switch on" symbol 

**Step 6.** Press CH button to store in memory.

**Step 7.** Press day button twice to display Mon to Fri again.

**Step 8.** Press the H+ and the M+ to set the first "off" time of the day.

**Step 9.** Press on  button to select "Switch off" symbol 

**Step 10.** Press CH to store.

**Step 11.** Press day twice, H+, M+ and then CH for each on and off period for a single day. The times for Mon to Fri have now been stored

Then it is necessary to set the current day and time. Please refer to the relevant section page 32.

# Instruction for setting the built in clock (cont.)

## For the weekend times:

**Step 1.** Press day three times to display Sat and Sun.

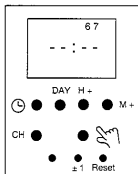

**Step 2.** As before Press the H+ and the M+ to set the first "on" time of the day.

**Step 9.** Press day three times, H+, M+ and then CH for each on and off period for a single day. The times for the whole weekend have now been stored

**Step 10.** By repeatedly pressing CH each of the times entered can be viewed and checked. At this stage an individual day's times can be changed. When that day is displayed, press H+ and M+ as required.

Note: If only partial information is entered and stored in memory e.g. only hours, or no days are set, then the switching sequence will be ignored.

## To Set The Current Day And Time

Press and hold the button whilst pressing the day, H+

(hours) and M+ (minutes) buttons to set the current day and time.

## The Override Button

The override button has four functions.

### Auto (starting position)

The boiler will turn on and off as programmed.

Press once for advance /override

If boiler is in "off" mode will switch it on.

If boiler is in "on" mode will switch boiler Off.

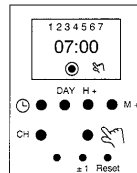

Press again for "FIX ON"

Boiler is now permanently on.

Press again for "FIX OFF"

Boiler is now permanently off.

Press again to go back to Auto.



# Instruction for setting the built in clock (cont.)

## Note :

When a manual override is used, the boiler will revert back to the auto setting at the next switching time. When the "Fix On" or "Fix Off" position is used, the boiler will only revert back to the auto position by pressing the  button.

## One Hour Button $\pm 1h$

This button is used to advance or set back the time by one hour for British Summer / Winter time. There is an indicator on the screen.

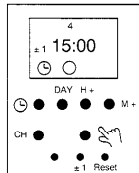





Chaffoteaux et Maury are continuously improving their products and therefore reserve the right to change specifications without prior notice and accepts no liability for any errors or omission in the information contained in this document.

© Chaffoteaux et Maury 1996

Chaffoteaux et Maury Ltd  
Trench Lock  
Trench  
Telford  
Shropshire  
TF1 4SZ

Tel: 01952 222727  
Fax: 01952 243493



January 1999

**ESP036**

**Chaffoteaux  
et Maury** 

92220-144b AG509E07F09b