

# micro GENUS

## Installation Instructions

### Type C Boilers

G.C.N: 47-116-14

47-116-15

LEAVE THESE INSTRUCTIONS  
WITH THE END-USER



*The code of practice for the installation,  
commissioning & servicing of central heating systems*

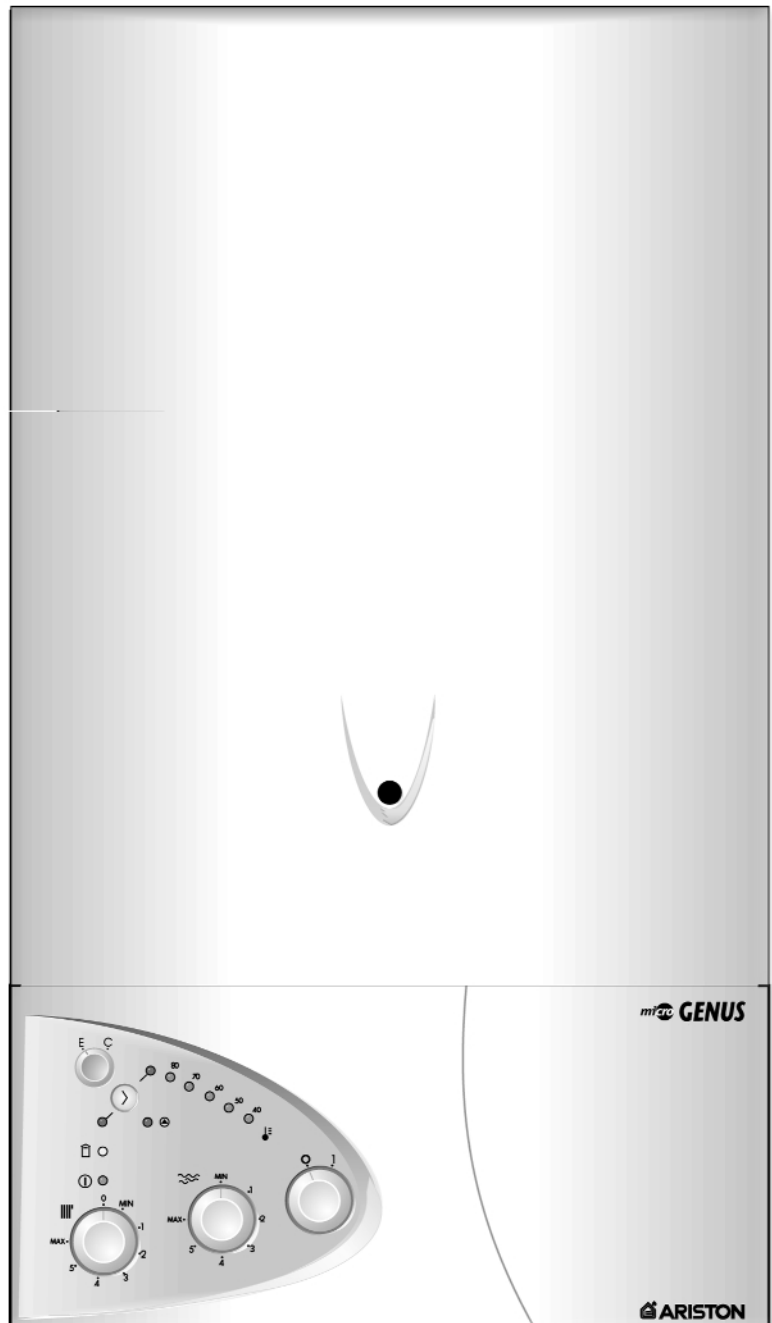

 **ARISTON**

# **TABLE OF CONTENTS**

## **1. GENERAL INFORMATION**

- 1.1 GENERAL INSTRUCTIONS
- 1.2 OVERALL VIEW

## **2. INSTALLATION**

- 2.1 REFERENCE STANDARDS
- 2.2 SITING THE APPLIANCE
- 2.3 OVERALL DIMENSIONS
- 2.4 CLEARANCES
- 2.5 MOUNTING THE APPLIANCE
- 2.6 ELECTRICAL CONNECTION
- 2.7 GAS CONNECTION
- 2.8 WATER CONNECTIONS
- 2.9 FLUE CONNECTION
- 2.10 ROOM THERMOSTAT CONNECTION
- 2.11 ELECTRICAL/SYSTEM DIAGRAMS
- 2.12 WATER CIRCUIT DIAGRAMS

## **3. COMMISSIONING**

- 3.1 INITIAL PREPARATION
- 3.2 CONTROL PANEL
- 3.3 REMOVING THE FRONT PANEL
- 3.4 INITIAL START UP
- 3.5 OPERATIONAL ADJUSTMENTS
- 3.6 COMBUSTION ANALYSIS
- 3.7 FUME DISCHARGE MONITORING
- 3.8 BOILER SAFETY SYSTEMS
- 3.9 DRAINING THE SYSTEM

## **4. GAS ADJUSTMENTS**

### **GAS ADJUSTMENT TABLE**

- 4.1 CHANGING THE TYPE OF GAS

## **5. MAINTENANCE**

## **6. MISCELLANEOUS**

- 6.1 WIRING DIAGRAM FOR TWO HEATING ZONES
- 6.2 WIRING DIAGRAM FOR CONNECTION TO AN ARISTON UNVENTED CYLINDER

## **7. TECHNICAL INFORMATION**

## 1. GENERAL INFORMATION

This manual is an integral and essential part of the product. It should be kept with the appliance so that it can be consulted by the user and our authorised personnel.

Please carefully read the instructions and notices about the unit contained in this manual, as they provide important information regarding the safe installation, use and maintenance of the product.

For operating instructions please consult the separate User's Manual.

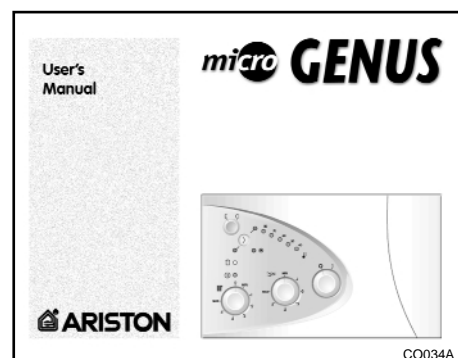

### 1.1 GENERAL INSTRUCTIONS

Read the instructions and recommendations in these Installation Instructions carefully to ensure proper installation, use and maintenance of the appliance.

Keep this manual in a safe place. You may need it for your own reference while our Servicing Centre technicians or your installer may need to consult it in the future.

This is a combined appliance for the production of central heating (C.H.) and domestic hot water (D.H.W.).

This appliance **must be used only** for the purpose for which it is designed. The manufacturer declines all liability for damage caused by improper or negligent use.

No asbestos or other hazardous materials have been used in the fabrication of this product.

**Before connecting** the appliance, check that the information shown on the data plate and the table on pages 4-5 comply with the electric, water and gas mains of the property. You will find the data plate on the reverse of the control panel. The gas with which this appliance operates is also shown on the label at the bottom of the boiler.

**Do not** install this appliance in a damp environment or close to equipment which spray water or other liquids.

**Do not place** objects on the appliance.

**Do not allow** children or inexperienced persons to use the appliance without supervision.

If you smell gas in the room, **do not turn on** light switches, use the telephone or any other object which might cause sparks.

Open doors and windows immediately to ventilate the room.

Shut the gas mains tap (on the gas meter) or the valve of the gas cylinder and call your Gas Supplier immediately.

If you are going away for a long period of time, remember to shut the mains gas tap or the gas cylinder valve.

**Always disconnect** the appliance either by unplugging it from the mains or turning off the mains switch before cleaning the appliance or carrying out maintenance.

**In the case of faults or failure**, switch off the appliance and turn off the gas tap. Do not tamper with the appliance.

For repairs, call your local Authorised Servicing Centre and request the use of original spare parts. For in-guarantee repairs contact MTS (GB) Limited.

**Check** the following at least once a year:

- 1 - Check the seals for the water connections; replacement of any faulty seals.
- 2 - Check the gas seals; replacement of any faulty gas seals.
- 3 - Visual check of the entire unit.
- 4 - Visual check of the combustion process or analysis of combustion by-products (see section 3.6) and cleaning of the burner if needed.

- 5 - If called for by point. 3, dismantling and cleaning of the combustion chamber.
- 6 - If called for by point. 4, dismantling and cleaning of the burner jets.
- 7 - Visual check of the primary heat exchanger:
  - check for overheating in the blade assembly;
  - clean the exhaust fan if needed.
- 8 - Adjustment of the flow rate of the gas: flow rate for lighting, partial load and full load.
- 9 - Check of the heating safety systems:
  - safety device for maximum temperature;
  - safety device for maximum pressure.
- 10- Check of the gas safety systems:
  - safety device for lack of gas or flame ionisation (detection electrode);
  - safety device for gas cock.
- 11- Check of the electrical connection (make sure it complies with the instructions in the manual).
- 12- Check of domestic hot water production efficiency (flow rate and temperature)
- 13- General check of the combustion by-products of the discharge/ventilation system.
- 14- Check of the general performance of the unit.

**FIG. 1.0**

## 1.2 OVERALL VIEW

### LEGEND:

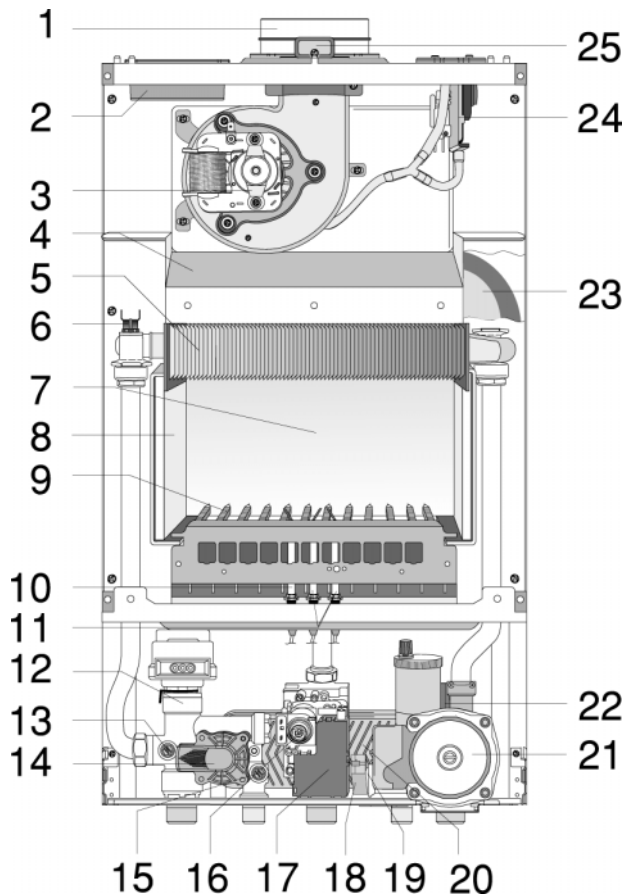

1. Flue connector
2. Air intake for twin pipe flue systems
3. Fan
4. Combustion chamber hood
5. Main heat exchanger
6. Safety thermostat
7. Combustion chamber
8. Combustion chamber insulation panel
9. Burner
10. Detection electrode
11. Ignition electrodes
12. Motorised diverter valve
13. Main circuit temperature probe
14. Main circuit flow switch
15. Domestic hot water temperature probe
16. Gas valve
17. Spark generator
18. Domestic hot water flow switch
19. Domestic cold water inlet filter
20. Secondary heat exchanger
21. Circulation pump with automatic air release valve
22. Safety valve (3 bar)
23. Expansion vessel
24. Air pressure switch
25. Combustion analysis intakes

IN013A

## 2. INSTALLATION

The technical information and instructions provided herein below are intended for the installer so that the unit may be installed correctly and safely.

### 2.1 REFERENCE STANDARDS

The installation and initial start up of the boiler must be by a CORGI Approved Installer in compliance with the installation standards currently in effect, as well as with any and all local health and safety standards i.e.. CORGI .

***This appliance must be installed by a competent installer in accordance with current Gas Safety (installation & use) Regulations.***

The installation of this appliance must be in accordance with the relevant requirements of the current Gas Safety (installation & use) Regulations, the Local Building Regulations, the current I.E.E. Wiring Regulations, the byelaws of the local water authority, and in Scotland, in accordance with the Building Standards (Scotland) Regulation and Health and Safety document No. 635 "Electricity at work regs. 1989".

Installation should also comply with the following British Standard Codes of Practice:

Low pressure pipes	BS 6891	1988
Boilers of rated input not exceeding 60 kW	BS 6798	1987
Forced circulation hot water system	BS 5449	1990
Installation of gas hot water supplies for domestic purposes ( 2 <sup>nd</sup> family gases)	BS 5546	1990
Flues	BS 5440-1	1990
Air supply	BS 5440-2	1989

### 2.2 SITING THE APPLIANCE

The appliance may be installed in any room or indoor area, although particular attention is drawn to the requirements of the current I.E.E. Wiring Regulations, and in Scotland, the electrical provisions of the Building Regulations applicable in Scotland, with respect to the installation of the combined appliance in a room containing a bath or shower.

**Where a room-sealed appliance is installed in a room containing a bath or shower the boiler and any electrical switch or appliance control, utilising mains electricity should be situated so that it cannot be touched by a person using the bath or shower.**

The location must permit adequate space for servicing and air circulation around the appliance as indicated in paragraph 2.4.

The location must permit the provision of an adequate flue and termination.

For unusual locations special procedures may be necessary.

BS 6798-1987 gives detailed guidance on this aspect.

A compartment used to enclose the appliance must be designed specifically for this purpose. No specific ventilation requirements are needed for the installation within a cupboard.

This appliance is not suitable for outdoor installation.

***The type C appliances (in which the combustion circuit, air vent intake and combustion chamber are air-tight with respect to the room in which the appliance is installed) can be installed in any type of room.***

There are no limitations with respect to ventilation and the volume of the room itself. The boiler must be installed on a solid, permanent wall to prevent access to the electrical parts (when live) through the aperture on the back frame.

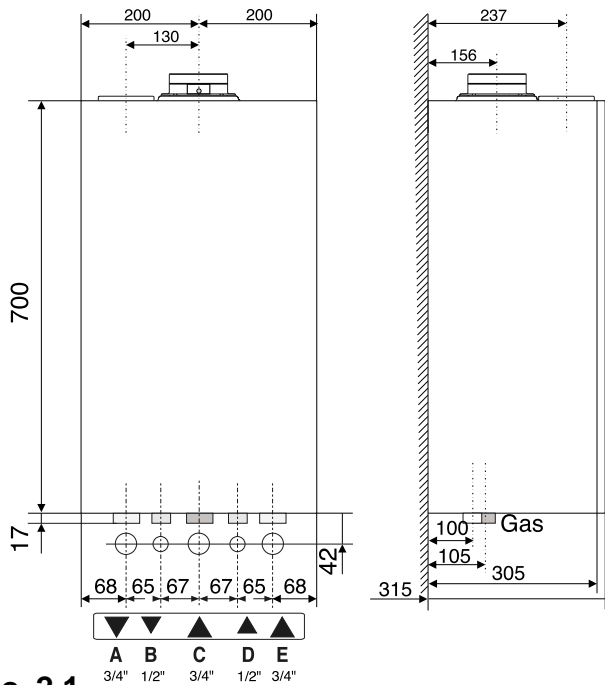

Fig. 2.1

QT002A

## 2.3 OVERALL DIMENSIONS

### LEGEND:

- A = Central Heating Flow (3/4")
- B = Domestic Hot Water Outlet (1/2")
- C = Gas Inlet (3/4")
- D = Domestic Cold Water Inlet (1/2")
- E = Central Heating Return (3/4")

## 2.4 CLEARANCES

In order to allow for access to the interior of the boiler for maintenance purposes, the boiler must be installed in compliance with the minimum clearances indicated in Fig. 2.2

## 2.5 MOUNTING THE APPLIANCE

Fasten the boiler in place using the template and anchors supplied with the unit. It is highly recommended that a spirit level be used to position the boiler so that it is perfectly level.

For additional information, please consult the instructions contained in the connection kit and the flue kit.

## 2.7 ELECTRICAL CONNECTION

For safety purposes, have a competent person carefully check the electrical system in the property, as the manufacturer will not be held liable for damage caused by the failure to earth the appliance properly or by anomalies in the supply of power. Make sure that the residential electrical system is adequate for the maximum power absorbed by the unit, which is indicated on the rating plate. In addition, check that the section of cabling is appropriate for the power absorbed by the boiler.

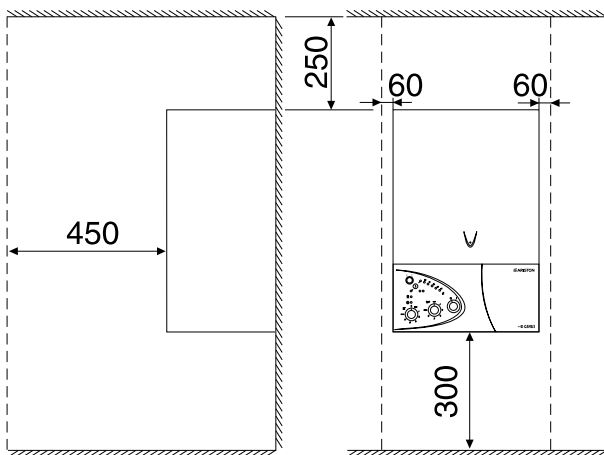

Fig. 2.2

DM004A

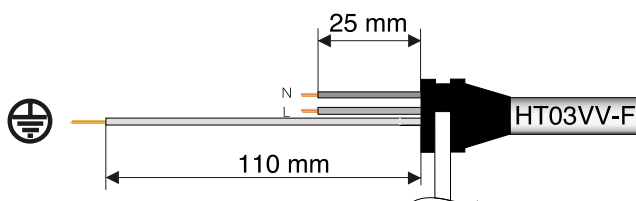

Fig. 2.3

VR001A

### IMPORTANT!

In the event that the power supply cord must be changed, replace it with one with the same specifications. Make the connections to the terminal board located within the control panel, as follows:

- The yellow-green wire should be connected to the terminal marked with the "⊕" symbol; make sure to reuse the ferrule mounted on the other supply cord;
- The blue wire should be connected to the terminal marked "N";
- The brown wire should be connected to the terminal

marked "L".

Note: The diagrams for the electrical system are indicated in section 2.11.

**Warning, this appliance must be earthed.**

External wiring to the appliance must be carried out by a qualified technician and be in accordance with the current I.E.E. Regulations and applicable local regulations. The Genus range of boilers are supplied for connection to a 230 V- 50 Hz supply.

**The supply must be fused at 3 A.**

The method of connection to the electricity supply must facilitate complete electrical isolation of the appliance, by the use of a fused double pole isolator having a contact separation of at least 3 mm in all poles or alternatively, by means of a 3 A fused three pin plug and unswitched shuttered socket outlet both complying with BS 1363.

The point of connection to the Electricity supply must be readily accessible and adjacent to the appliance unless the appliance is installed in a bathroom when this must be sited outside the bathroom.

**2.8 GAS CONNECTION**

The local gas region contractor connects the gas meter to the service pipe. If the gas supply for the boiler serves other appliances ensure that an adequate supply is available both to the boiler and the other appliances when they are in use at the same time.

Pipe work must be of an adequate size. Pipes of a smaller size than the boiler inlet connection should not be used.

**2.9 WATER CONNECTIONS**

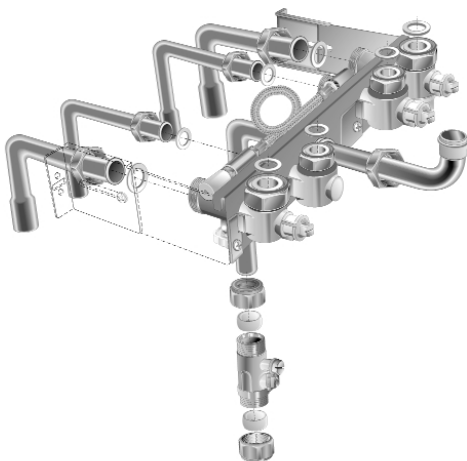

**FIG. 2.5**

KT002A

**VIEW OF THE BOILER CONNECTIONS**

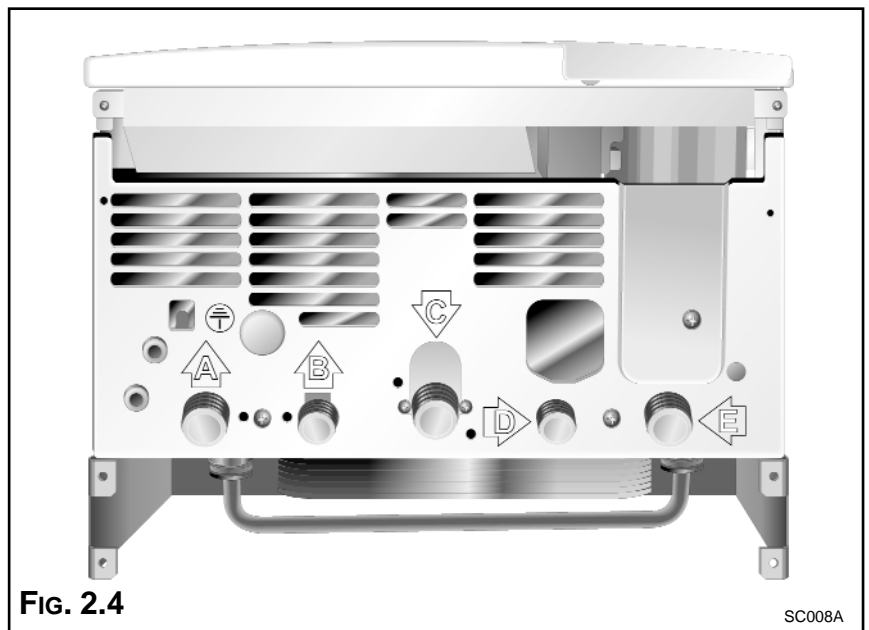

**FIG. 2.4**

SC008A

**LEGEND:**

- A = Central Heating Flow
- B = Domestic Hot Water Outlet
- C = Gas Inlet
- D = Domestic Cold Water Inlet
- E = Central Heating Return
- F = Safety Valve

**CENTRAL HEATING**

Detailed recommendations are given in BS 6798:1987 and BS 5449-1:1990, the following notes are given for general guidance.

*PIPE WORK:*

Copper tubing to BS EN 1057:1996 is recommended for water pipes. Jointing should be either with capillary soldered or compression fittings. Where possible pipes should have a gradient to ensure air is carried naturally to air release points and water flows naturally to drain taps.

The appliance has a built-in automatic air release valve, however it should be ensured as far as possible that the appliance heat exchanger is not a natural collecting point for air.

Except where providing useful heat, pipes should be insulated to prevent heat loss and avoid freezing.

Particular attention should be paid to pipes passing through ventilated spaces in roofs and under floors.

*BY-PASS:*

The appliance includes an automatic by-pass valve, which protects the main heat exchanger in case of reduced or interrupted water circulation through the heating system, due to the closing of thermostatic valves or cock-type valves within the system.

*SYSTEM DESIGN:*

This boiler is suitable only for sealed systems.

*Drain Cocks:*

These must be located in accessible positions to permit the draining of the whole system. The taps must be at least 15mm nominal size and manufactured in accordance with BS 2870:1980.

*SAFETY VALVE DISCHARGE:*

The discharge should terminate facing downward on the exterior of the building in a position where discharging (possibly boiling water & steam) will not create danger or nuisance, but in an easily visible position, and not cause damage to electrical components and wiring.

The discharge must not be over an entrance or a window or any other type of public access.

*AIR RELEASE POINTS:*

These must be fitted at all high points where air naturally collects and must be sited to facilitate complete filling of the system.

The appliance has an integral sealed expansion vessel to accommodate the increase of water volume when the system is heated.

It can accept up to 6 l (1.3 gal) of expansion water. If the heating circuit has an unusually high water content, calculate the total expansion and add an additional sealed expansion vessel with adequate capacity.

*MAINS WATER FEED - CENTRAL HEATING:*

There must be no direct connection to the mains water supply even through a non-return valve, without the approval of the Local Water Authority.

*FILLING:*

A temporary method for initially filling the system and replacing lost water during servicing in accordance with Water Supply Byelaw 14 must be provided.

**DOMESTIC WATER**

The domestic water must be in accordance with the relevant recommendation of BS 5546:1990. Copper tubing to BS EN 1057:1996 is recommended for water carrying pipe work and must be used for pipe work carrying drinking water.

**RESIDUAL HEAD OF THE BOILER**

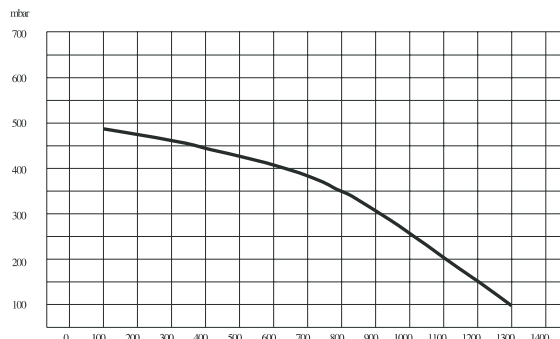



## 2.9 FLUE CONNECTIONS

### FLUE SYSTEM

The provision for satisfactory flue termination must be made as described in BS 5440-1.

The appliance must be installed so that the flue terminal is exposed to outdoor air. The terminal must not discharge into another room or space such as an outhouse or lean-to.

It is important that the position of the terminal allows a free passage of air across it at all times.

The terminal should be located with due regard for the damage or discolouration that might occur on buildings in the vicinity.

In cold or humid weather water vapour may condense on leaving the flue terminal.

The effect of such "steaming" must be considered.

If the terminal is less than 2 metres above a balcony, above ground or above a flat roof to which people have access, then a suitable terminal guard must be fitted. When ordering a terminal guard, quote the appliance model number.

A suitable terminal guard is available from:

### TOWER FLUE COMPONENTS

Morley Road

Tonbridge

Kent TN9 1RA

The minimum acceptable spacing from the terminal to obstructions and ventilation openings are specified in **Fig. 2.6**.

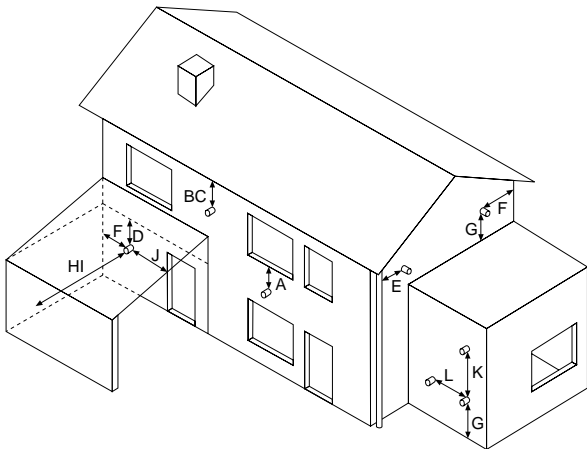
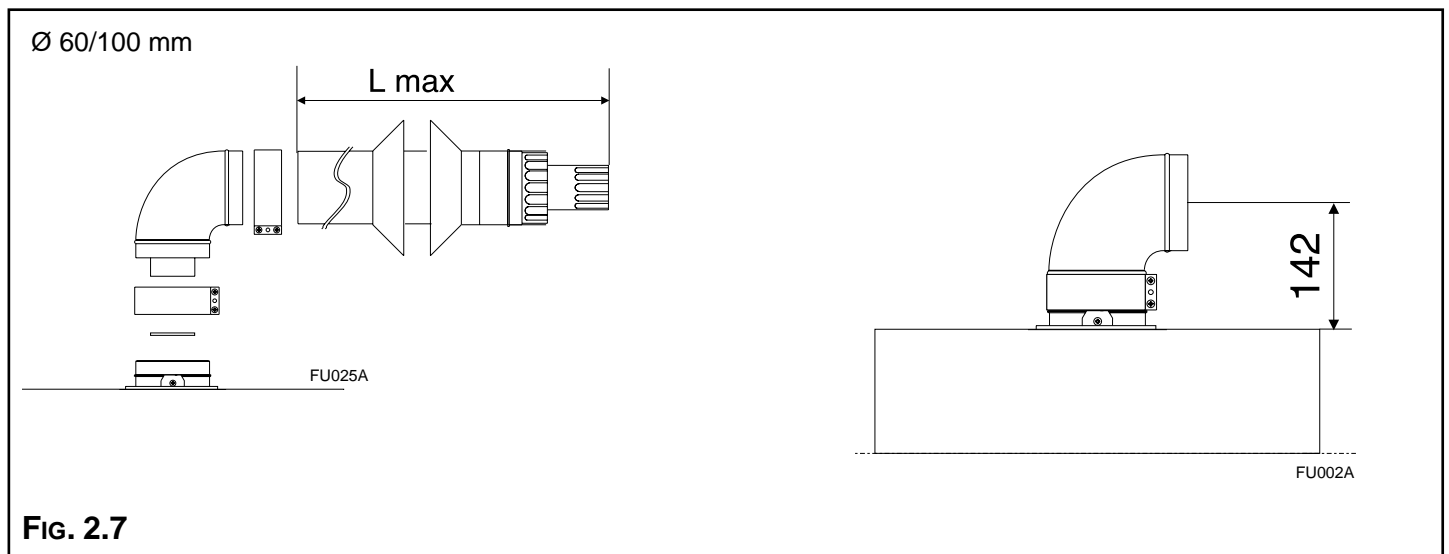

**Fig. 2.6**

FU010A

TERMINAL POSITION	mm
A - Directly below an open window or other opening	300
B - Below gutters, solid pipes or drain pipes	75
C - Below eaves	200
D - Below balconies or car-port roof	200
E - From vertical drain pipes and soil pipes	75
F - From internal or external corners	300
G - Above ground or below balcony level	300
H - From a surface facing a terminal	600
I - From a terminal facing a terminal	1200
J - From an opening in the car port (e.g. door, window) into dwelling	1200
K - Vertically from a terminal in the same wall	1500
L - Horizontally from a terminal in the same wall	300

The boiler is designed to be connected to a coaxial flue discharge system.



**Fig. 2.7**

In addition, it is also possible to use a split (twin pipe) system by fitting a special adaptor to the flue connector and using the aperture for the air vent intake located on the top part of the combustion chamber.

To utilise the air intake it is necessary to:

1. Remove the bottom of the air intake by cutting it with a suitable knife (see **FIG. 2.8**);
2. Insert the elbow into the air intake until it reaches the lower end. (There is no need to use gaskets or sealing compounds).

The components marked \* in **FIG. 2.9** are present or absent depending on the type of flue system used by the installer.

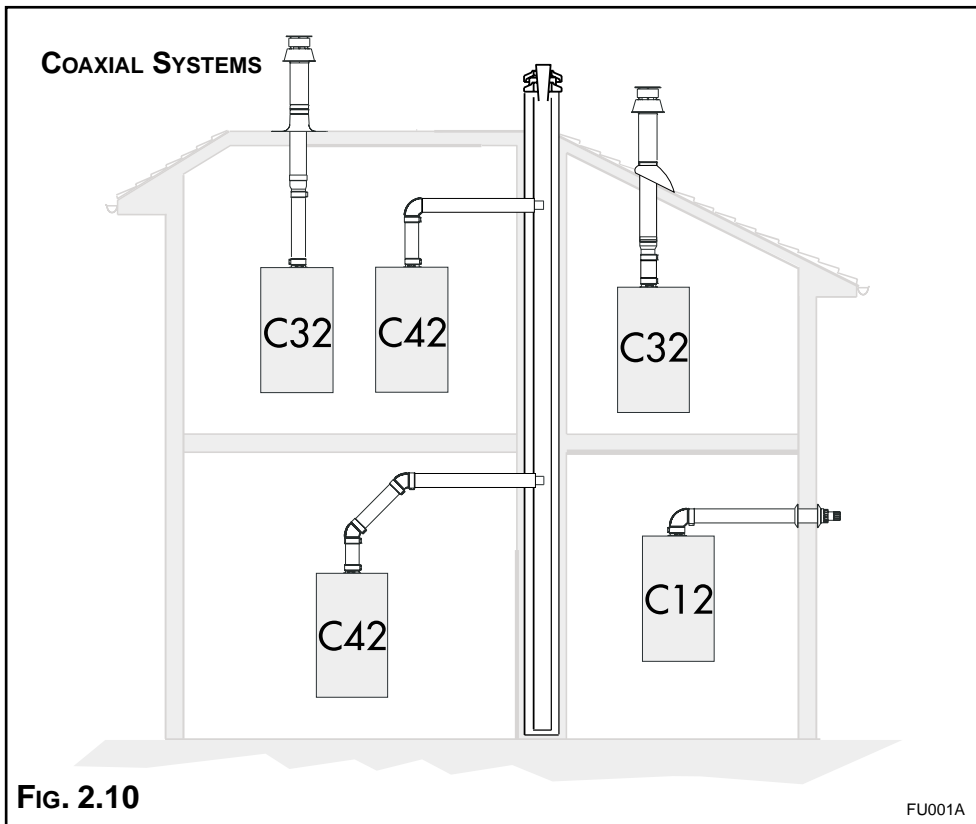
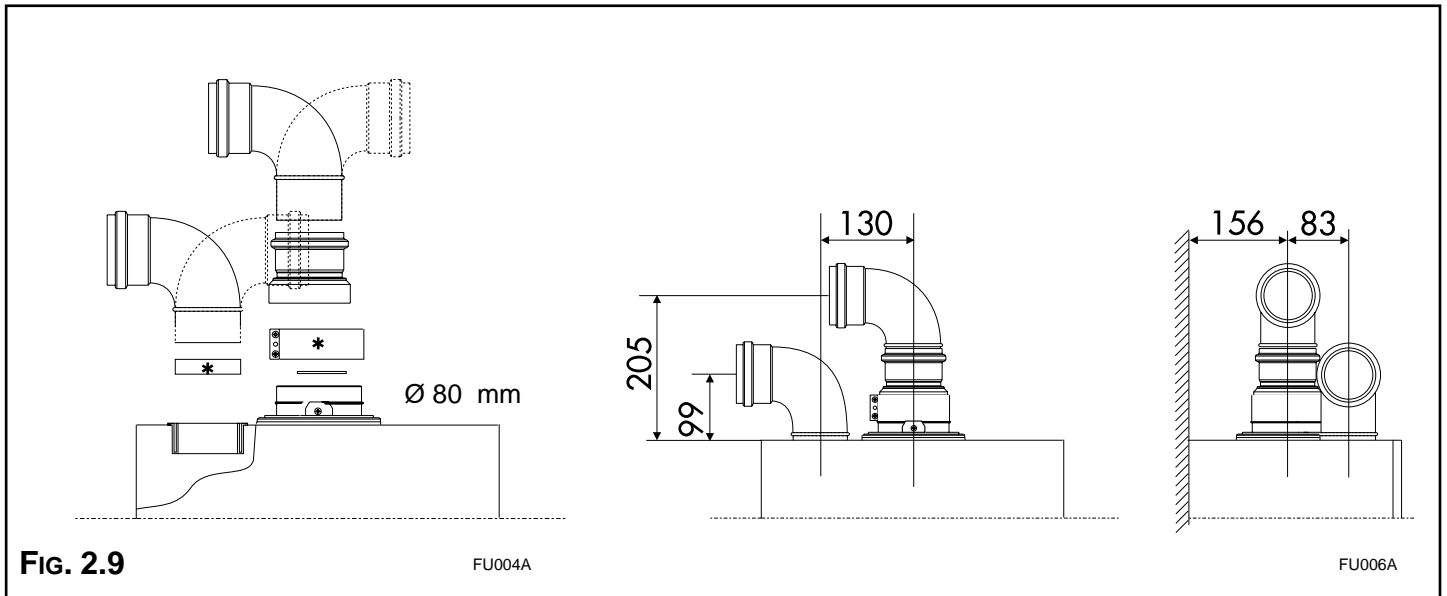
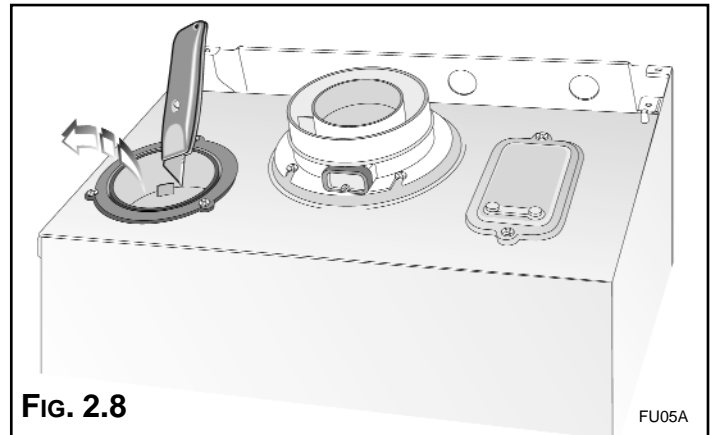

**IMPORTANT!**

For all flue systems, a restrictor must always be inserted into the boiler's flue connector; the restrictor must be  $\varnothing 43$  or  $\varnothing 41$  in diameter depending on the length of piping indicated in Table 2.1.

The diagrams illustrate some of the various designs for coaxial or twin pipe flue systems. For further information on discharge/ventilation accessories, see the **FLUE PIPE ACCESSORIES MANUAL**.

	Exhaust Type	Restrictor ø 43 mm	NO Restrictor	Maximum Extension Exhaust/Air	Risk of Condensation Forming			
					Piping not insulated ø 43 restrictor NO		Piping insulated ø 43 restrictor NO	
Coaxial Systems ø 60/100	C12 (xx)	L min = 0.5 m L max = 2 m	L min = 2 m L max = 4 m	L = 4 m	NONE	NONE	NONE	NONE
	C32 (xx)							
	C42 (xx)							
	Exhaust Type	Restrictor ø 43 mm	NO Restrictor	Maximum Extension Exhaust/Air	Risk of Condensation Forming			
					Piping not insulated ø 43 restrictor NO		Piping insulated ø 43 restrictor NO	
Twin Pipe Systems ø 80/80	C12 (xy)	L max = 11.5 m	L min = 11.5 m L max = 43 m	43 m	4.3 m	6.9 m	NONE	NONE
	C32 (xy)			43 m				
	C42 (xy)			43 m				
	C52 (xy)	L max = 11,4 m	L min = 11,4 m	40 m	4.3 m	6.9 m	5,7 m	21,7 m
	C82 (xy)		L max = 40m					

**micro GENUS 27 MFFI**

	Exhaust Type	Restrictor ø 41 mm	NO Restrictor	Maximum Extension Exhaust/Air	Risk of Condensation Forming			
					Piping not insulated ø 41 restrictor NO restrictor		Piping insulated ø 41 restrictor NO restrictor	
Coaxial Systems ø 60/100	C12 (xx)	L min = 0.5 m L max = 1 m	L min = 1 m L max = 4 m	L = 4 m	NONE	NONE	NONE	NONE
	C32 (xx)							
	C42 (xx)							
	Exhaust Type	Restrictor ø 41 mm	NO Restrictor	Maximum Extension Exhaust/Air	Risk of Condensation Forming			
					Piping not insulated ø 41 restrictor NO restrictor		Piping insulated ø 41 restrictor NO restrictor	
Twin Pipe Systems ø 80/80	C12 (xy)	L max = 38 m	L min = 38 m L max = 62 m	62 m	8 m	11 m	19 m	31 m
	C32 (xy)			62 m				
	C42 (xy)			62 m				
	C52 (xy)	L max = 34 m	L min = 34 m	54 m	8 m	11 m	19 m	31 m
	C82 (xy)		L max = 54 m					

L = Sum of the total length of exhaust + air intake piping.

## TWIN PIPE SYSTEMS

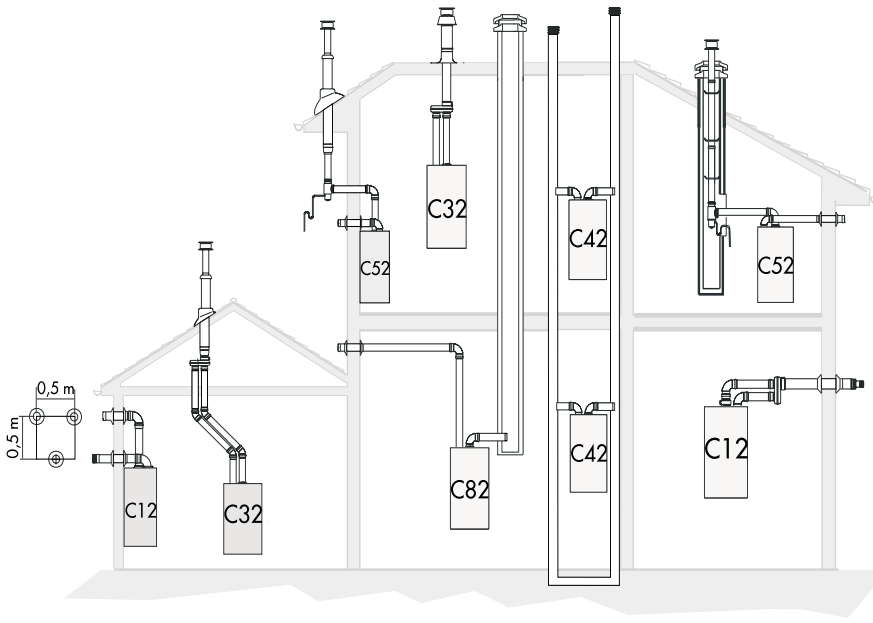

FIG. 2.11

FU007A

In calculating the lengths of the pipes, the maximum length "L" must also take into consideration the values for the exhaust/air intake end terminals, as well as 90° elbows for coaxial systems.

The C52 types must comply with the following requirements:

- 1 - The exhaust/ air intake pipes must have the same diameter of  $\varnothing$  80 mm.
- 2 - If elbows are to be inserted into the air intake and/or exhaust system, the calculation of the overall length must take into consideration the values for each elbow, see the **FLUE PIPE ACCESSORIES MANUAL**.
- 3 - The exhaust pipe must protrude by at least 0.5 m above the top of the roof in the event that it is located on the opposite side to the side with the air intake (this condition is not obligatory when the air intake and exhaust are located on the same side of the building).

## 2.10 ROOM THERMOSTAT CONNECTION

To connect a room thermostat, it is necessary to:

1. - Open the control panel as indicated in section 3.3.
- 2.- Remove the link "A" from the terminal block on the reverse of the control panel.
3. - Insert the thermostat cable through the cable grommet and fasten it by means of the cable-clamp provided.
4. - Then connect the thermostat wires to the terminal block.
- 5.- If a remote time clock is to be fitted, disconnect the integral time clock from the P.C.B.
6. - Using a volt-free switching time clock, connect the switching wires from the time clock following points 1-4 above.
7. - If using an external time clock and room thermostat, these must be connected in series as points 1-7 above.

**Note:** Only a two-wire type room thermostat can be used.

**An anti-frost device is built-in to the appliance's electronic regulation system.**

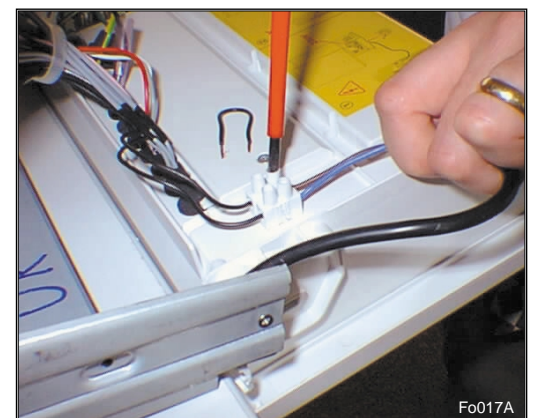
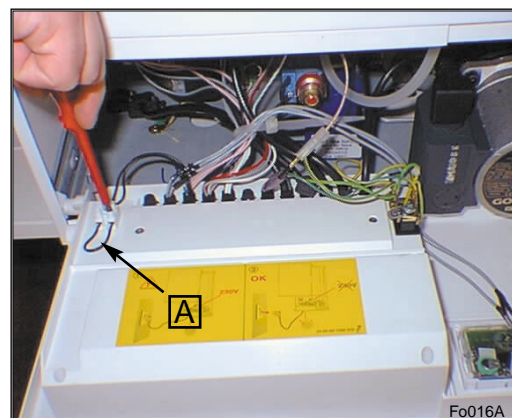

## 2.12 ELECTRICAL DIAGRAM

### LEGEND:

- A** = Time Clock Connector  
**B** = Central Heating Selection (Winter) and Temperature Adjustment  
**C** = Connector for Total Check System  
**D** = Domestic Hot Water Temperature Adjustment  
**E** = Soft-light Adjustment  
**F** = Maximum Heating Adjustment  
**G** = On/Off Switch  
**H** = On/Off L.E.D.  
**I** = Fume Sensor L.E.D.  
**J** = Ignition Failure (Lockout) L.E.D.  
**K** = Low System Water Level/Lack of Circulation L.E.D.  
**L** = Reset Button  
**M** = Economy/Comfort Selector  
**N** = Overheat L.E.D.  
**O** = Temperature L.E.D.s  
**P** = Transformer  
**Q** = Circulation Pump Relay  
**R** = Fan Relay  
**S** = Gas Valve Relay  
**T** = Motorised Diverter Valve Relay  
**V** = Spark Generator  
**U** = Anti-cycling Device Adjustment for Heating

- A01** = Circulation Pump  
**A02** = Fan  
**A03** = Spark Generator/Gas Valve Supply  
**A04** = Motorised Diverter Valve  
**A05** = Flame Detection Circuit  
**A06** = Detection Electrode  
**A07** = Main Circuit Temperature Probe  
**A08** = Domestic Hot Water Temperature Probe  
**A09** = Domestic Hot Water Flow Switch  
**A10** = Main Circuit Flow Switch  
**A11** = Modulator  
**A12** = Air Pressure Switch  
**A13** = Safety Thermostat  
**A14** = External (Room) Thermostat

### Colours:

- Gry** = Grey  
**Wh** = White  
**Pnk** = Pink  
**Brn** = Brown  
**Bl** = Blue  
**Blk** = Black  
**Rd/Blk** = Red/Black

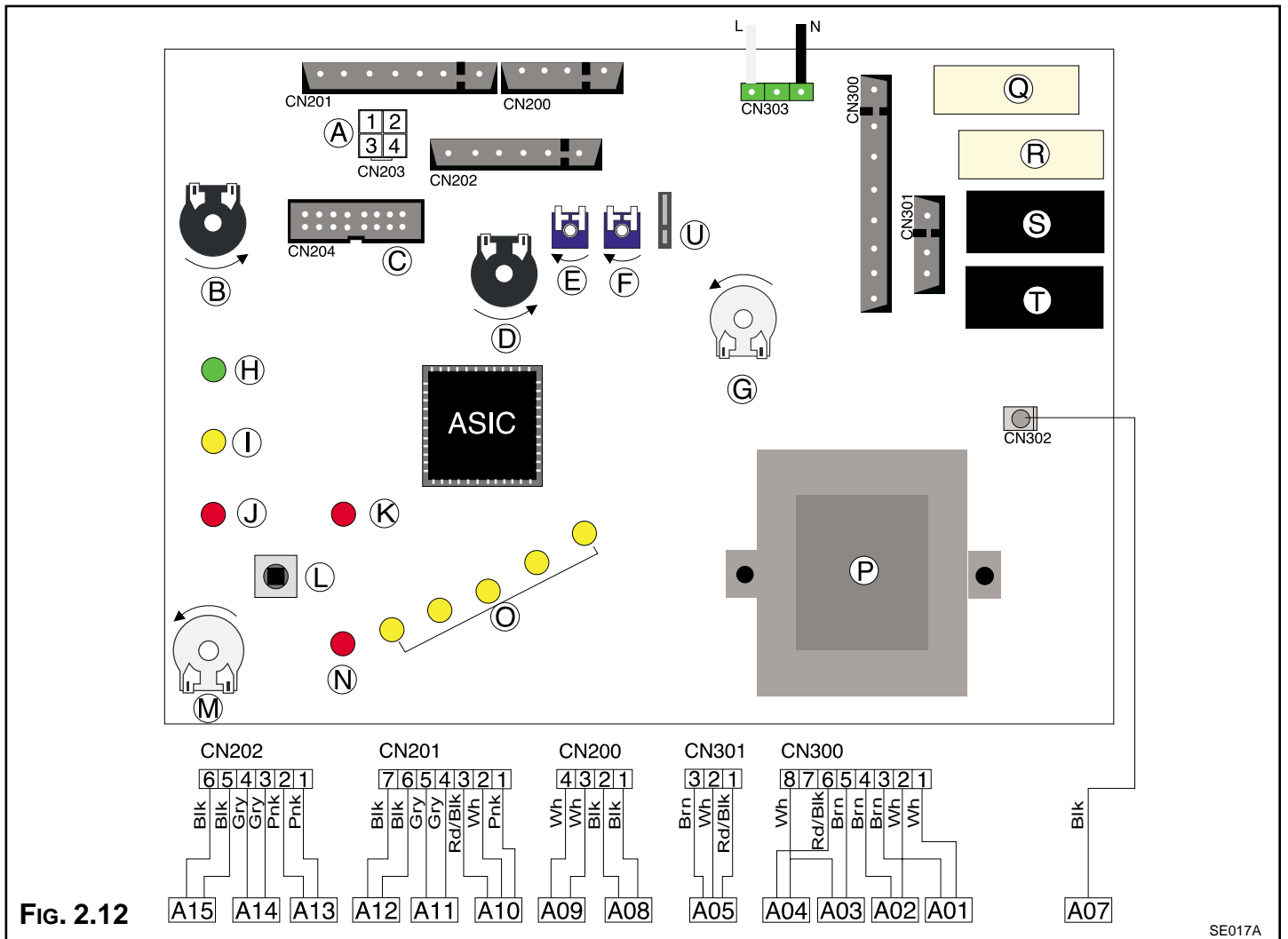
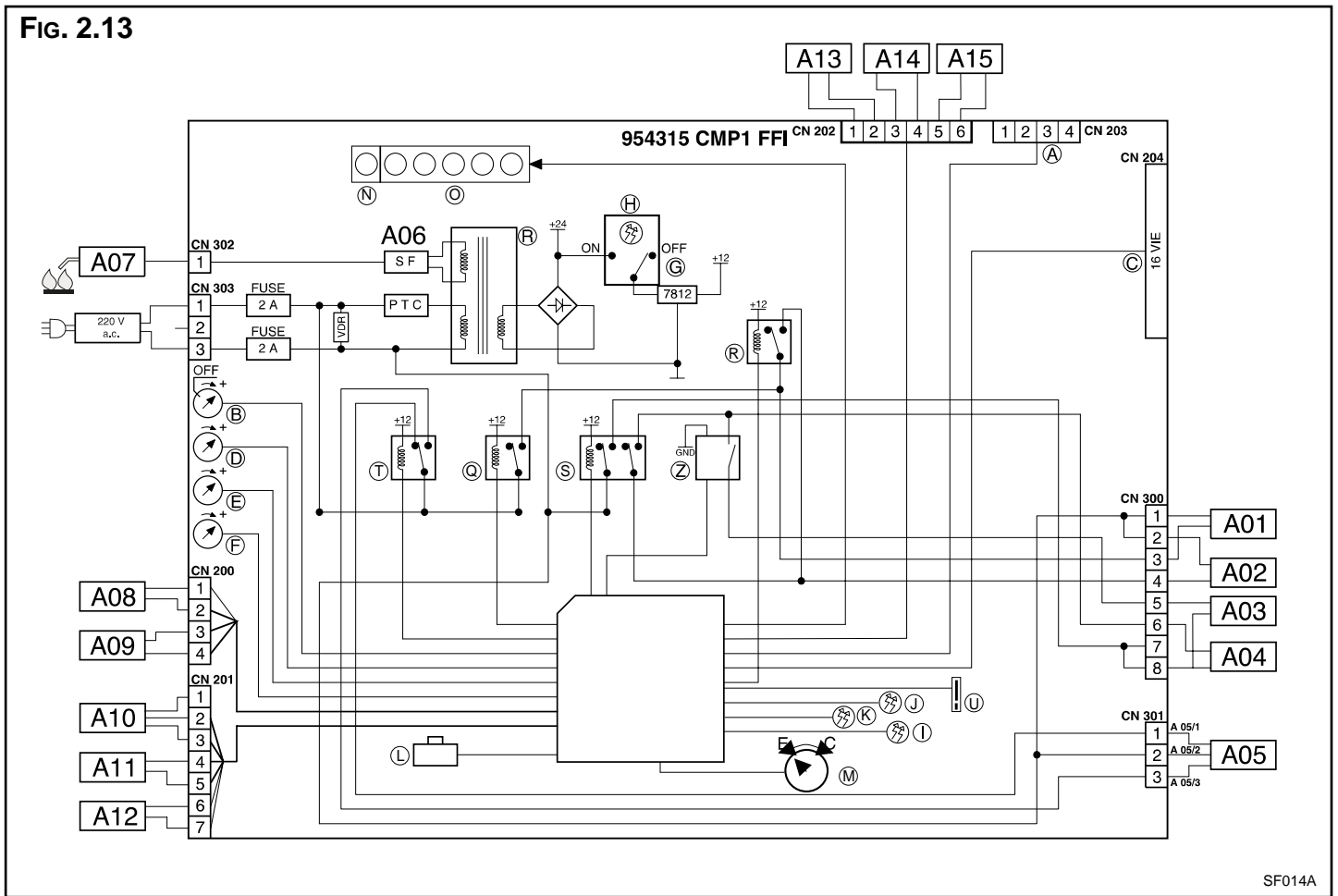

FIG. 2.12

**FIG. 2.13**



SF014A

**2.13 WATER CIRCUIT DIAGRAM**

**FIG. 2.14**

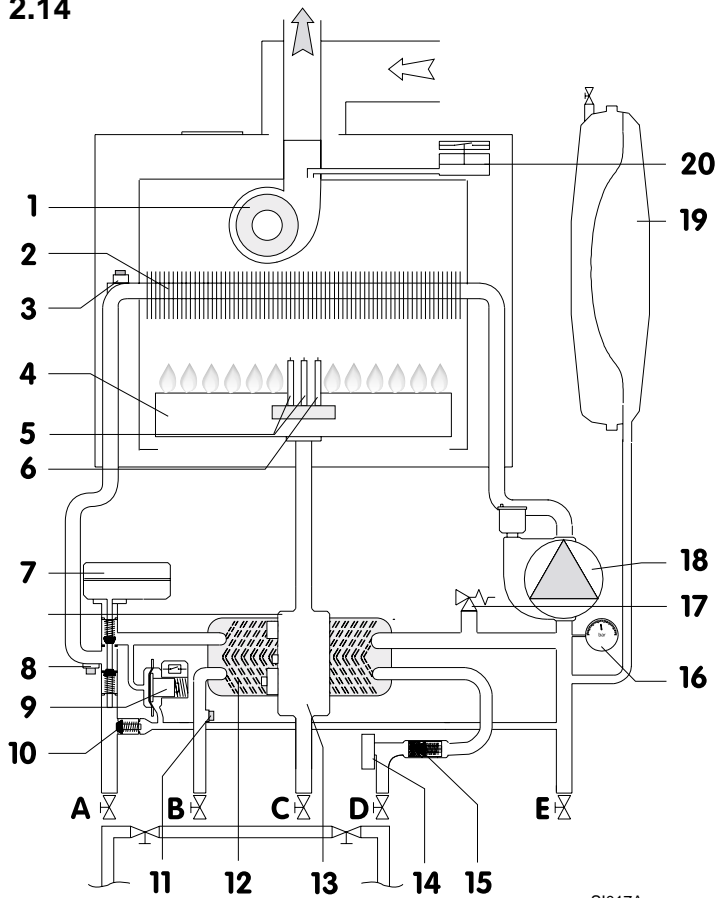

**LEGEND:**

1. Fan
  2. Main Heat Exchanger
  3. Overheat Thermostat
  4. Burner
  5. Ignition Electrodes
  6. Detection Electrode
  7. Motorised Valve
  8. Main Circuit Temperature Probe
  9. Main Circuit Flow Switch
  10. Automatic By-pass
  11. Domestic Hot Water Temperature Probe
  12. Secondary Heat Exchanger
  13. Gas Valve
  14. Domestic Hot Water Flow Switch
  15. Domestic Water Inlet Filter
  16. Pressure Gauge
  17. Safety Valve
  18. Circulation Pump with Automatic Air Release Valve
  19. Expansion Vessel
  20. Air Pressure Switch
- A. Central Heating Flow  
 B. Domestic Hot Water Outlet  
 C. Inlet Gas  
 D. Domestic Cold Water Inlet  
 E. Central Heating Return

SI017A

### 3. COMMISSIONING

#### 3.1 INITIAL PREPARATION

MTS (GB) Limited support the *benchmark* initiative. Within the information pack you will find a copy of the *benchmark* logbook. It is important that this is completed in the presence of your customer, they are shown how to use it, and it is signed by them. Please instruct your customer that they must have their *benchmark* logbook with them whenever they contact a service engineer or us.

Preliminary electrical system checks to ensure electrical safety must be carried out by a competent person i.e. polarity, earth continuity, resistance to earth and short circuit.

##### *FILLING THE HEATING SYSTEM:*

Remove the panels of the case and lower the control panel (see section 3.3 for further information).

Open the central heating flow and return cocks supplied with the connection kit.

Unscrew the cap on the automatic air release valve one full turn and leave open permanently.

Close all air release valves on the central heating system.

Gradually open valve(s) at the filling point (filling-loop) connection to the central heating system until water is heard to flow, do not open fully.

Open each air release tap starting with the lower point and close it only when clear water, free of air, is visible.

**Purge the air from the pump by unscrewing anticlockwise the pump plug and also manually rotate the pump shaft in the direction indicated by the pump label to ensure the pump is free.**

Close the pump plug.

Continue filling the system until at least 1 bar registers on the pressure gauge.

Inspect the system for water soundness and remedy any leaks discovered.

##### *FILLING OF THE D.H.W. SYSTEM:*

Close all hot water draw-off taps.

Open the cold water inlet cock supplied with the connection kit.

Open slowly each draw-off tap and close it only when clear water, free of bubbles, is visible

##### *GAS SUPPLY:*

Inspect the entire installation including the gas meter, test for soundness and purge, all as described in BS 6891:1988.

Open the gas cock (supplied with the connection kit) to the appliance and check the gas connector on the appliance for leaks.

When the installation and filling are completed turn on the central heating system (section 3.4) and run it until the temperature has reached the boiler operating temperature. The system must then be immediately flushed through.

The flushing procedure must be in line with BS 7593:1992 code of practice for treatment of water in domestic hot water central heating systems.

During this operation, we highly recommend the use of a central heating flushing detergent (Fernox Superfloc or equivalent), whose function is to dissolve any foreign matter that may be in the system.

**Substances different from these could create serious problems to the pump or other components.**

The use of an inhibitor in the system such as Fernox MB-1 or equivalent is strongly recommended to prevent corrosion (*sludge*) damaging the boiler and system.

**Failure to carry out this procedure may invalidate the appliance warranty.**

## 3.2 CONTROL PANEL

### LEGEND:

- A - On/Off knob
- B - Domestic hot water temperature adjustment knob
- C - Central heating selection (winter) and temperature adjustment knob
- D - On/Off L.E.D. (green)
- E - Fume sensor L.E.D. (yellow)
- F - Ignition failure (lockout) L.E.D. (red)
- G - "Economy/Comfort" mode selection knob
- H - Ignition failure (lockout) and/or overheat reset button
- I - Overheat L.E.D. (red)
- J - Low system water level L.E.D. (red)
- K - Central heating temperature L.E.D. (yellow)
- L - Time clock
- M - Heating system pressure gauge

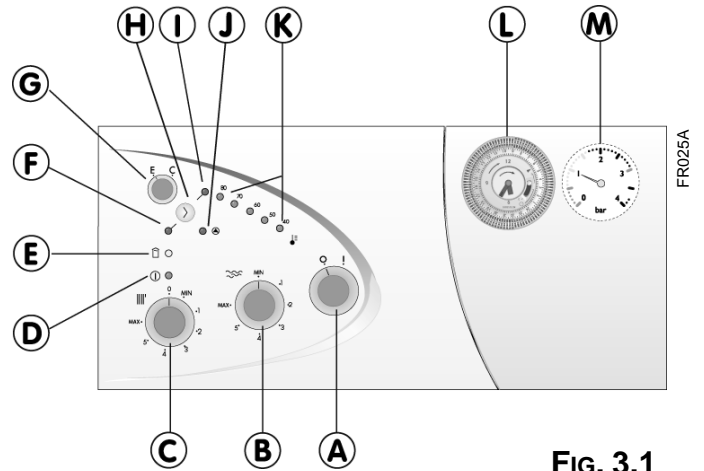
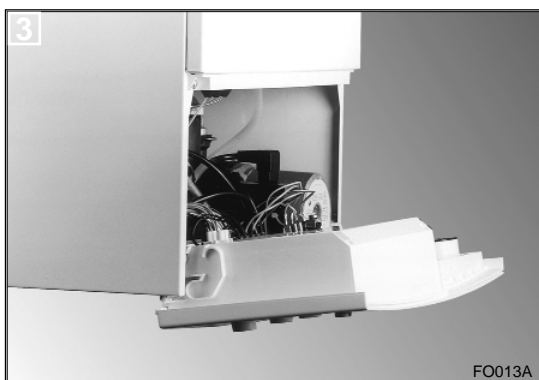
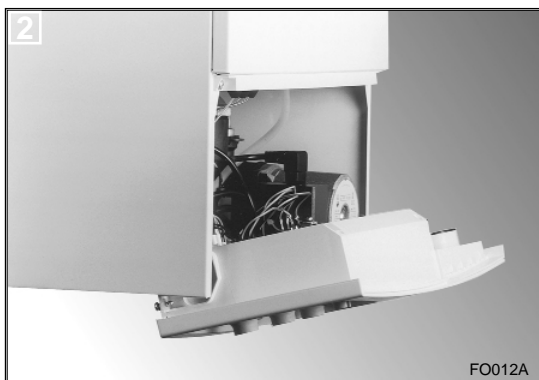
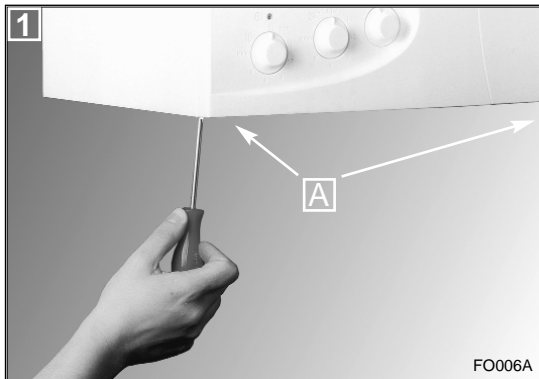

FIG. 3.1

## 3.3 REMOVING THE FRONT PANEL



In order to access the inside of the boiler, it is necessary to unscrew the fastening screws "A" of the control panel located on the lower part of the panel itself.

The control panel moves downward and when pulled forward rotates on two lateral hinges.

The panel stays in a semi-horizontal position, which allows access to the inner parts of the boiler.

In order to increase the maneuvering space, it is possible to raise the control panel and rotate it to a fully horizontal position.

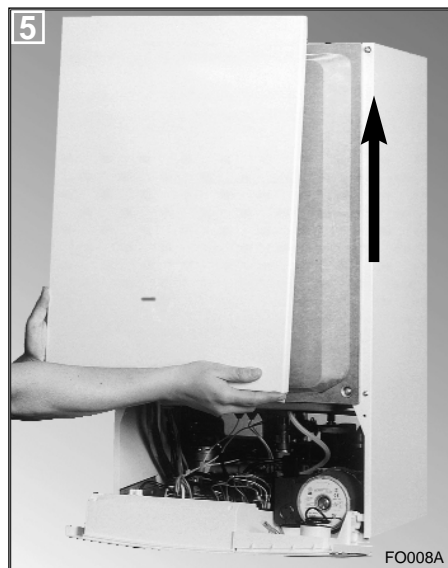
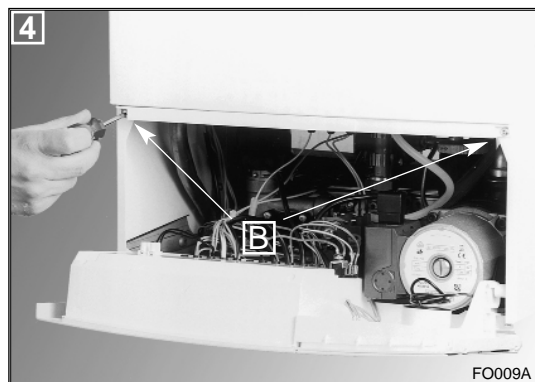

To dismantle the front casing panel it is necessary to:

- 1 - Remove the two screws "B";
- 2 - Lift the front casing panel up and forward.



### 3.4. INITIAL START-UP

*THE CHECKS TO BE RUN BEFORE INITIAL START-UP ARE AS FOLLOWS:*

1. Make sure that:
  - the screw on the automatic air valve has been loosened when the system is full;
  - If the water pressure in the system is below 1 bar, bring it up to the appropriate level;
  - Check to see whether the gas cock is closed;
  - Make sure that the electrical connection has been made properly and that the earth wire is connected to an efficient earthing system;
  - Supply power to the boiler by turning the On/Off switch “A” (see **FIG.3.1**)
    - the L.E.D. “D” will illuminate - turn the selector knob “C” to the winter /central heating position. This will start the circulation pump. After 7 seconds, the boiler will signal a shutdown due to ignition failure. Leave the boiler as it is until all of the air has been bled from the lines.
  - Loosen the cap on the head of the pump to eliminate any air pockets;
  - Repeat the procedure for bleeding the radiators of air;
  - Open the taps for a brief period;
  - Check the system pressure and, if it has dropped, open the filling loop again to bring the pressure back up to 1 bar.
2. Check the exhaust flue for the fumes produced by combustion.
3. Make sure that all gate valves are open;
4. Turn on the gas cock and check the seals on the connections, including the one for the burner, making sure that the meter does not signal the passage of gas. Check the connections with a soap solution and eliminate any leaks.
5. Press the reset button “A” for the lighting system; the spark will light the main burner. If the burner does not light the first time, repeat the procedure.
6. Check the minimum and maximum pressure values for the gas going to the burner; adjust it if needed using the values indicated in the table in section 4 (See the relative section for burner pressure adjustment within the servicing manual).

### 3.5 OPERATIONAL ADJUSTMENTS

(See section 3.2 for references) it is possible to:

- Set the temperature of the heating system by adjusting the knob “C”
- Set the temperature of the domestic hot water by turning knob “B”
- The selector knob “G” allows the user to choose the economy mode (position “E”) or the comfort mode (position “C”).

The economy mode is the normal state for the operation of the boiler, since the domestic water is heated up only when a tap is turned on.

The comfort mode is a special operating state, because the water contained in the secondary exchanger and in the primary exchanger is kept in a preheated condition, thereby allowing a quicker delivery of domestic water when required. The latter is therefore the more convenient choice.

To access the areas in which adjustments are made, it is necessary to open the control panel, as indicated in section 3.3, then remove the rear inspection cover by unscrewing the two screws. Access is thereby provided to the P.C.B. and to the following components:

1. the power supply cable connector;
2. the fuses;
3. the soft-light potentiometer the setting for which can range from the minimum thermal power to the maximum;
4. the maximum thermal heating power potentiometer adjustable by the minimum to maximum power (already calibrated in the factory to 70% of the maximum thermal power);
5. the potentiometer for adjusting the ignition delay (anti-cycling) feature, which can be set from 0 to 2 minutes (set in the factory at one minute);
6. the time clock connector.

### 3.6 COMBUSTION ANALYSIS

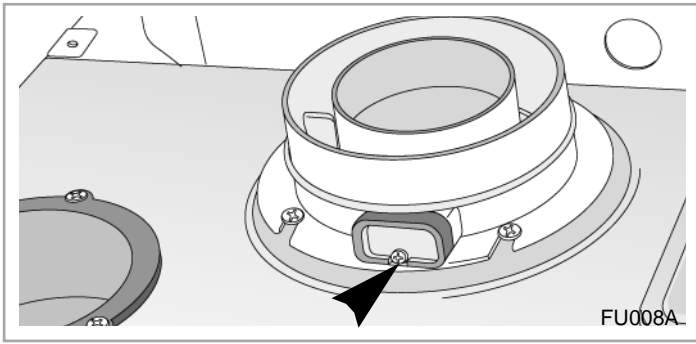

The flue connector has two apertures, readings can be taken for the temperature of the combustion by-products and of the combustion air, as well as of the concentrations of O<sub>2</sub> and CO<sub>2</sub>, etc. .

To access these intakes it is necessary to unscrew the front screw and remove the metal plate with sealing gasket. The best test conditions, with the maximum heating power, are achieved by turning the selector knob “C” to the “max” position and removing the electrical connection to the heating sensor (see section 6.).

### 3.7 FUME DISCHARGE MONITORING

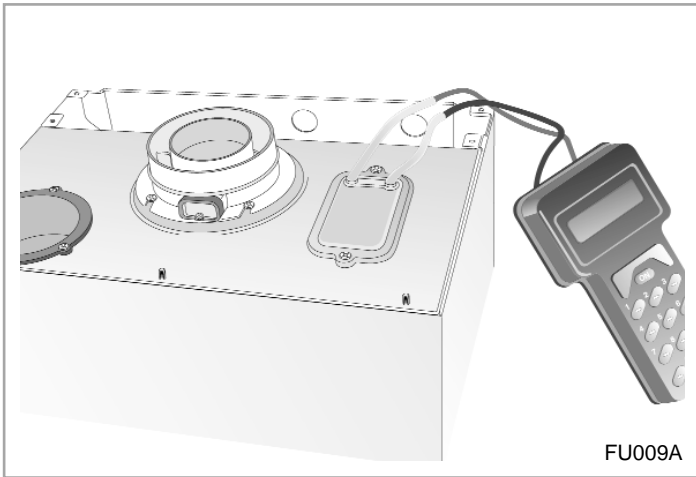

In the boiler, it is possible to monitor the correct operation of the flue exhaust/air intake, checking for a loss of general pressure in the system. Through the use of a differential manometer connected to the test points of the combustion chamber, it is possible to detect the  $\Delta P$  of operation of the air pressure switch.

The value detected should not be less than 0,55 mbar for 23kW and 0.75 mbar for 27kW under conditions of maximum thermal power in order for the boiler to function properly and without interruption.

### 3.8 BOILER SAFETY SYSTEMS

The boiler is fitted with the following devices (see section 3.2 for references).

1 - *IGNITION FAILURE:*

This control signals an ignition failure on the burner 7 seconds after a lighting failure. The L.E.D. “F” will illuminate to signal the shutdown status.

The system can be reset by pressing and releasing the button “H” after checking to make sure that the gas cock is open.

2 - *CIRCULATION FAILURE:*

This control signals that the safety pressure switch on the primary circuit has not sensed a pressure of at least 1 bar within 40 seconds of the activation of the circulation pump; the circulation pump comes to a halt and the red L.E.D. “J” illuminates.

The system may be reset, after re-establishing the correct level of pressure in the boiler, turning the “A” knob.

3 - *OVERHEATING:*

This control shuts off the boiler in the case where the primary circuit reaches a temperature in excess of 105°C.

The red L.E.D.s “I” and “F” will illuminate to signal this shutdown status.

The system can be reset by waiting a few minutes for the primary exchanger to cool down and then by pressing and releasing the “H” button.

4. *LIMESCALE BUILD-UP:*

The boiler is equipped with a device that limits the formation of Limescale in the secondary exchanger by controlling the temperature of the domestic hot water (max 61°C) and also controlling the temperature of the water in the primary heating circuit.

5. *ANTI-FROST DEVICE:*

The boiler is equipped with a device that, in the event of the water temperature going below 5°C, the 3-way diverter valve switches to domestic hot water and the burner ignites at the minimum power until the boiler water reaches a temperature of about 50°C.

This device operates only if the boiler is functioning perfectly and:

- the system pressure is sufficient;
- the boiler is powered electrically;
- the gas is distributed.

6 - *EXHAUST DISCHARGE ANOMALY SHUTDOWN:*

The boiler is fitted with safety devices, which in the event of defective discharge of exhaust fumes, automatically interrupts the gas supply, thereby shutting off the boiler.

The shutdown of the boiler is temporary and is indicated by the illumination of the yellow L.E.D. "E" for a period of about 15 minutes.

Once this time period has passed and the discharge state of exhaust fumes has returned to normal, the boiler automatically turns back on.

7 - *SAFETY SHUTDOWN:*

At the start of every lighting phase, the P.C.B. performs a series of internal controls. If a malfunction occurs, the boiler will shutdown until the problem has been resolved.

### 3.9 DRAINING THE SYSTEM

#### ***DRAINING THE HEATING SYSTEM***

The heating system must be emptied as follows:

- Turn off the boiler;
- Open the drain valve for the system and place a container below to catch the water that comes out;
- Empty the system at the lowest points (where present). If you plan on not using the heating system for an extended period of time, it is recommended that you add antifreeze with an ethylene glycol base to the water in the heating lines and radiators if the ambient temperature drops below 0°C during the winter.

This makes repeated draining of the entire system unnecessary.

#### ***DRAINING THE DOMESTIC HOT WATER SYSTEM***

Whenever there is the danger of the temperature dropping below the freezing point, the domestic hot water system must be drained as follows:

- Turn off the general water valve for the household plumbing system;
- Turn on all the hot and cold water taps;
- Empty the remaining water from the lowest points in the system (where present).

## 4. GAS ADJUSTMENTS

CATEGORY I12H3+		Methane Gas G20	Liquid Butane Gas G30	Liquid Propane Gas G31
Lower Wobbe Index (15°C;1013mbar)	MJ/m <sup>3</sup> h	45.67	80.58	80.58
Nominal Delivery Pressure	mbar	20	29	37
Minimum Delivery Pressure	mbar	17	20	25
<b>23 MFFI</b>				
Main Burner: n. 13 jets (∅)	mm	1.30	0.77	0.77
Consumption (15°C; 1013mbar)	mc/h	2.72	----	----
Consumption (15°C; 1013mbar)	Kg/h	----	2.02	2.02
Gas Cock Outlet Pressure max - min	mbar	11.0 - 2.0	(*) - 6.0	(*) - 6.0
<b>27 MFFI</b>				
Main Burner: n. 15 jets (∅)		1.30	0.77	0.77
Consumption (15°C; 1013mbar)	mc/h	3.15	----	----
Consumption (15°C; 1013mbar)	Kg/h	----	2.34	2.31
Gas Cock Outlet Pressure: max - min	mbar	11.0 - 1.6	(*) - 4.6	(*) - 6.0

[1 mbar = 10,197 mmc.a.]

The outlet pressure of the gas cock is obtained by completely loosening the screw on the solenoid. The maximum pressure of the gas to the burner will be equal to the nominal delivery pressure minus the head loss within the gas valve.

### 4.1 CHANGING THE TYPE OF GAS

***The boiler can be converted to use either methane (natural) gas (G20) or LPG (G30 - G31) by an Authorised Service Centre.***

The operations that must be performed are the following:

1. Replace the jets on the main burner (see table in section 4);
2. Adjust the maximum and minimum thermal capacity values for the boiler (see table in section 4);
3. Replace the gas rating plate;
4. Adjust the maximum thermal power setting;
5. Adjust the soft-light feature;
6. Adjust the ignition delay feature for the heating system (can be set from 0 to 2 mins.).

CATEGORY I12H3+	Methane Gas G20	Liquid Butane Gas G30	Liquid Propane Gas G31
Recommended Soft-light Pressure (mbar)	8.0	16.0	16.0

## **5. MAINTENANCE**

***It is recommended that the following inspections be carried out on the boiler at least once a year:***

- 1 - Check the seals for the water connections; replacement of any faulty seals.
- 2 - Check the gas seals; replacement of any faulty gas seals.
- 3 - Visual check of the entire unit.
- 4 - Visual check of the combustion process or analysis of combustion by-products (see section 3.6) and cleaning of the burner if needed.
- 5 - If called for by point. 3, dismantling and cleaning of the combustion chamber.
- 6 - If called for by point. 4, dismantling and cleaning of the burner jets.
- 7 - Visual check of the primary heat exchanger:
  - check for overheating in the blade assembly;
  - clean the exhaust fan if needed.
- 8 - Adjustment of the flow rate of the gas: flow rate for lighting, partial load and full load.
- 9 - Check of the heating safety systems:
  - safety device for maximum temperature;
  - safety device for maximum pressure.
- 10- Check of the gas safety systems:
  - safety device for lack of gas or flame ionisation (detection electrode);
  - safety device for gas cock.
- 11- Check of the electrical connection (make sure it complies with the instructions in the manual).
- 12- Check of domestic hot water production efficiency (flow rate and temperature)
- 13- General check of the combustion by-products of the discharge/ventilation system.
- 14- Check of the general performance of the unit.

# 7. MISCELLANEOUS

## 7.1 WIRING DIAGRAM FOR TWO HEATING ZONES

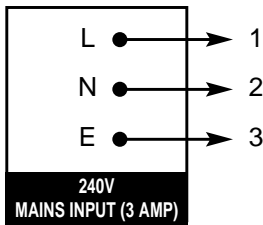
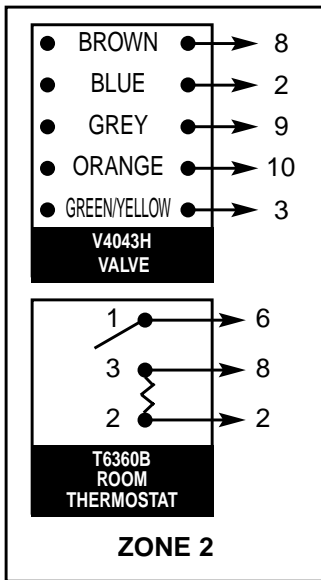
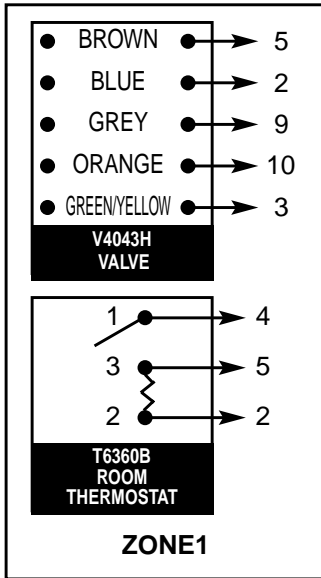

TYPICAL JUNCTION BOX

- 1
- 2
- 3
- 4
- 5
- 6
- 7
- 8
- 9
- 10

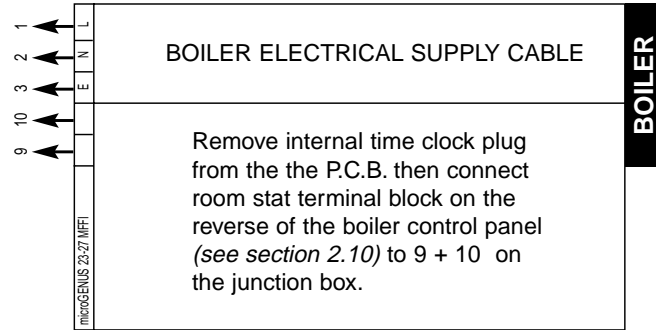

Terminal	1	2	3	4	5	6	7	8	9	10	Device	Terminal																																																																																																																																																											
1	N	L										1																																																																																																																																																											
2												2																																																																																																																																																											
3												3																																																																																																																																																											
4												4																																																																																																																																																											
5												5																																																																																																																																																											
6												6																																																																																																																																																											
7												7																																																																																																																																																											
8												8																																																																																																																																																											
9												9																																																																																																																																																											
10												10																																																																																																																																																											
<table border="1"> <tr> <th>Device</th> <th>Terminal</th> <th>1</th> <th>2</th> <th>3</th> <th>4</th> <th>5</th> <th>6</th> <th>7</th> <th>8</th> <th>9</th> <th>10</th> </tr> <tr> <td>Pegler Survic SP 50/100 (Link L-3)</td> <td>2</td> <td></td> <td></td> <td></td> <td></td> <td></td> <td></td> <td></td> <td></td> <td></td> <td></td> </tr> <tr> <td>Switchmaster Symphony, Sonata</td> <td>1</td> <td></td> <td></td> <td></td> <td></td> <td></td> <td></td> <td></td> <td></td> <td></td> <td></td> </tr> <tr> <td>Switchmaster 400, 600</td> <td>3</td> <td></td> <td></td> <td></td> <td></td> <td></td> <td></td> <td></td> <td></td> <td></td> <td></td> </tr> <tr> <td>SWITCHMASTER 805, 900</td> <td>3</td> <td></td> <td></td> <td></td> <td></td> <td></td> <td></td> <td></td> <td></td> <td></td> <td></td> </tr> <tr> <td>Survic ET 1451 Link 2-3-6</td> <td>7</td> <td></td> <td></td> <td></td> <td></td> <td></td> <td></td> <td></td> <td></td> <td></td> <td></td> </tr> <tr> <td>Survic DHP 2201</td> <td>6</td> <td></td> <td></td> <td></td> <td></td> <td></td> <td></td> <td></td> <td></td> <td></td> <td></td> </tr> <tr> <td>Towerchron FP Link 1-3/47-9</td> <td>6</td> <td></td> <td></td> <td></td> <td></td> <td></td> <td></td> <td></td> <td></td> <td></td> <td></td> </tr> <tr> <td>Towerchron MIP Link 1-4/6-11</td> <td>6</td> <td></td> <td></td> <td></td> <td></td> <td></td> <td></td> <td></td> <td></td> <td></td> <td></td> </tr> <tr> <td>Towerchron 2000</td> <td></td> <td></td> <td></td> <td></td> <td></td> <td></td> <td></td> <td></td> <td></td> <td></td> <td></td> </tr> <tr> <td>ACL LS522, LS722</td> <td>3</td> <td></td> <td></td> <td></td> <td></td> <td></td> <td></td> <td></td> <td></td> <td></td> <td></td> </tr> <tr> <td>Randall 922, 972 Link L-2-5</td> <td>3</td> <td></td> <td></td> <td></td> <td></td> <td></td> <td></td> <td></td> <td></td> <td></td> <td></td> </tr> <tr> <td>Randall 3020 P and 3060</td> <td>4</td> <td></td> <td></td> <td></td> <td></td> <td></td> <td></td> <td></td> <td></td> <td></td> <td></td> </tr> </table>												Device	Terminal	1	2	3	4	5	6	7	8	9	10	Pegler Survic SP 50/100 (Link L-3)	2											Switchmaster Symphony, Sonata	1											Switchmaster 400, 600	3											SWITCHMASTER 805, 900	3											Survic ET 1451 Link 2-3-6	7											Survic DHP 2201	6											Towerchron FP Link 1-3/47-9	6											Towerchron MIP Link 1-4/6-11	6											Towerchron 2000												ACL LS522, LS722	3											Randall 922, 972 Link L-2-5	3											Randall 3020 P and 3060	4										
Device	Terminal	1	2	3	4	5	6	7	8	9	10																																																																																																																																																												
Pegler Survic SP 50/100 (Link L-3)	2																																																																																																																																																																						
Switchmaster Symphony, Sonata	1																																																																																																																																																																						
Switchmaster 400, 600	3																																																																																																																																																																						
SWITCHMASTER 805, 900	3																																																																																																																																																																						
Survic ET 1451 Link 2-3-6	7																																																																																																																																																																						
Survic DHP 2201	6																																																																																																																																																																						
Towerchron FP Link 1-3/47-9	6																																																																																																																																																																						
Towerchron MIP Link 1-4/6-11	6																																																																																																																																																																						
Towerchron 2000																																																																																																																																																																							
ACL LS522, LS722	3																																																																																																																																																																						
Randall 922, 972 Link L-2-5	3																																																																																																																																																																						
Randall 3020 P and 3060	4																																																																																																																																																																						

Terminal	1	2	3	4	5	6	7	8	9	10	Device	Terminal																																																																																																																																																																							
1	N	L										1																																																																																																																																																																							
2												2																																																																																																																																																																							
3												3																																																																																																																																																																							
4												4																																																																																																																																																																							
5												5																																																																																																																																																																							
6												6																																																																																																																																																																							
7												7																																																																																																																																																																							
8												8																																																																																																																																																																							
9												9																																																																																																																																																																							
10												10																																																																																																																																																																							
<table border="1"> <tr> <th>Device</th> <th>Terminal</th> <th>1</th> <th>2</th> <th>3</th> <th>4</th> <th>5</th> <th>6</th> <th>7</th> <th>8</th> <th>9</th> <th>10</th> </tr> <tr> <td>Honeywell ST 699B 1002 Link L-5-8</td> <td>6</td> <td></td> <td></td> <td></td> <td></td> <td></td> <td></td> <td></td> <td></td> <td></td> <td></td> </tr> <tr> <td>ST 6400/ST 6300 ST 6200</td> <td>3</td> <td></td> <td></td> <td></td> <td></td> <td></td> <td></td> <td></td> <td></td> <td></td> <td></td> </tr> <tr> <td>Drayton Tempus 7</td> <td>3</td> <td></td> <td></td> <td></td> <td></td> <td></td> <td></td> <td></td> <td></td> <td></td> <td></td> </tr> <tr> <td>Horstmann 425, 525, 527 Link L-2-5</td> <td>1</td> <td></td> <td></td> <td></td> <td></td> <td></td> <td></td> <td></td> <td></td> <td></td> <td></td> </tr> <tr> <td>Landis &amp; Gyr RWB2 Glowworm Mastermind</td> <td>3</td> <td></td> <td></td> <td></td> <td></td> <td></td> <td></td> <td></td> <td></td> <td></td> <td></td> </tr> <tr> <td>Landis &amp; Gyr RWB20 Microgr</td> <td>3</td> <td></td> <td></td> <td></td> <td></td> <td></td> <td></td> <td></td> <td></td> <td></td> <td></td> </tr> <tr> <td>Potterton Miniminder</td> <td>3</td> <td></td> <td></td> <td></td> <td></td> <td></td> <td></td> <td></td> <td></td> <td></td> <td></td> </tr> <tr> <td>Potterton EP2000/3000-Link L-5 EP2001/3001</td> <td>3</td> <td></td> <td></td> <td></td> <td></td> <td></td> <td></td> <td></td> <td></td> <td></td> <td></td> </tr> <tr> <td>Randall 102/102 E Link 3-6</td> <td>1</td> <td></td> <td></td> <td></td> <td></td> <td></td> <td></td> <td></td> <td></td> <td></td> <td></td> </tr> <tr> <td>Randall 4033 Link 1-6</td> <td>4</td> <td></td> <td></td> <td></td> <td></td> <td></td> <td></td> <td></td> <td></td> <td></td> <td></td> </tr> <tr> <td>Randall 701, 702 Link L-6-5</td> <td>3</td> <td></td> <td></td> <td></td> <td></td> <td></td> <td></td> <td></td> <td></td> <td></td> <td></td> </tr> <tr> <td>Sargamo M5 Link 1-6</td> <td>1</td> <td></td> <td></td> <td></td> <td></td> <td></td> <td></td> <td></td> <td></td> <td></td> <td></td> </tr> <tr> <td>Sargamo 410 Form 1 Link 3-6</td> <td>1</td> <td></td> <td></td> <td></td> <td></td> <td></td> <td></td> <td></td> <td></td> <td></td> <td></td> </tr> </table>												Device	Terminal	1	2	3	4	5	6	7	8	9	10	Honeywell ST 699B 1002 Link L-5-8	6											ST 6400/ST 6300 ST 6200	3											Drayton Tempus 7	3											Horstmann 425, 525, 527 Link L-2-5	1											Landis & Gyr RWB2 Glowworm Mastermind	3											Landis & Gyr RWB20 Microgr	3											Potterton Miniminder	3											Potterton EP2000/3000-Link L-5 EP2001/3001	3											Randall 102/102 E Link 3-6	1											Randall 4033 Link 1-6	4											Randall 701, 702 Link L-6-5	3											Sargamo M5 Link 1-6	1											Sargamo 410 Form 1 Link 3-6	1										
Device	Terminal	1	2	3	4	5	6	7	8	9	10																																																																																																																																																																								
Honeywell ST 699B 1002 Link L-5-8	6																																																																																																																																																																																		
ST 6400/ST 6300 ST 6200	3																																																																																																																																																																																		
Drayton Tempus 7	3																																																																																																																																																																																		
Horstmann 425, 525, 527 Link L-2-5	1																																																																																																																																																																																		
Landis & Gyr RWB2 Glowworm Mastermind	3																																																																																																																																																																																		
Landis & Gyr RWB20 Microgr	3																																																																																																																																																																																		
Potterton Miniminder	3																																																																																																																																																																																		
Potterton EP2000/3000-Link L-5 EP2001/3001	3																																																																																																																																																																																		
Randall 102/102 E Link 3-6	1																																																																																																																																																																																		
Randall 4033 Link 1-6	4																																																																																																																																																																																		
Randall 701, 702 Link L-6-5	3																																																																																																																																																																																		
Sargamo M5 Link 1-6	1																																																																																																																																																																																		
Sargamo 410 Form 1 Link 3-6	1																																																																																																																																																																																		

If a room thermostat is not required on Zone 1, insert a link between 4 + 5 on the junction box.  
 If a room thermostat is not required on Zone 2, insert a link between 6 + 8 on the junction box.

Based on Honeywell controls

## 7.2 WIRING DIAGRAM FOR CONNECTION TO AN ARISTON UNVENTED CYLINDER

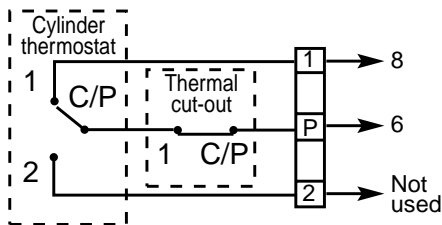
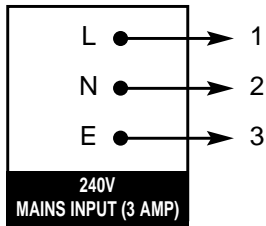
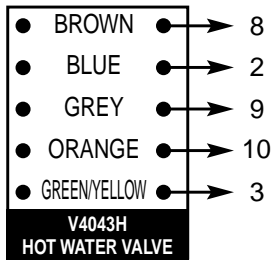
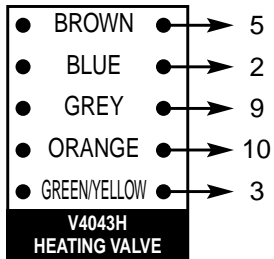
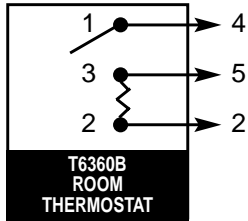

TYPICAL JUNCTION BOX

- 1
- 2
- 3
- 4
- 5
- 6
- 7
- 8
- 9
- 10

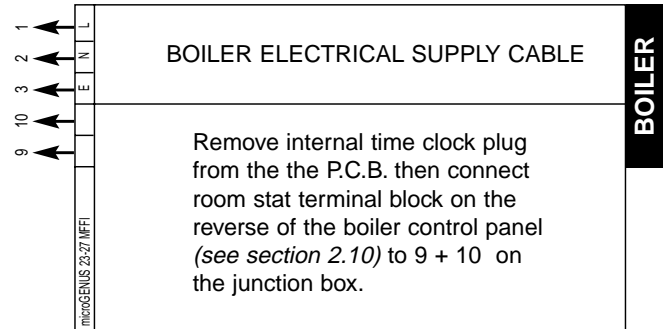

	1	2	3	4	5	6	7	8	9	10	PROGRAMMER
Pepler Sunvic SP50/100 (Link L-3)	L	N	L	E	5	2					
Switchmaster Symphony, Sonata	L	N	L		1	4					
Switchmaster 400, 600	L	N	L		3	1					
SWITCHMASTER 805, 900	L	N	L		3	1					
Sunvic ET 1451 Link 2-3-6	1	2			7	4					
Sunvic DHP 2201	2				6	3					
Towerchron FP Link 1-5,4-7-9	1	2			6	10					
Towerchron MP Link 1-4/6-11	1	2			6	10					
Towerchron 2000	L	N	L						HTG ON		
ACL LS522, LS722	L	N	L		3	4					
Randall 922, 972 Link L-2-5	L	N	L		3	6					
Randall 3020 P and 3060	L	N	L		4	2					

	1	2	3	4	5	6	7	8	9	10	PROGRAMMER
Honeywell ST 698B 1002 Link L-5-8	L	N	L	6	3						
ST 6400/ST 6300 ST 6200	L	N	L	3	4						
Drayton Tempus 7	L	N	L	3	4						
Horstmann 425, 525, 527 Link L-2-5	L	N	L	1	4	E					
Landis & Gyr RWB2 Glowworm Mastermind	L	N	L	3	4						
Landis & Gyr RWB20 Microgyr	L	N	L	3	4						
Potterton Miniminder	L	N	L	3	4						
Potterton EP200/3000 - Link L-5 - EP2001/3001	L	N	L	3	4						
Randall 102/102 E Link 3-6	6	5		1	2	E					
Randall 4033 Link 1-6	6	7		4	2	E					
Randall 701, 702 Link L-6-5	L	N	L	3	1	E					
Sangamo M5 Link 1-6	3	4		1	8	E					
Sangamo 410 Form 1 Link 3-6	3	4		1	8	E					

Based on Honeywell controls

## 7. TECHNICAL INFORMATION

		<b>mic GENUS 23 MFFI</b>	<b>mic GENUS 27 MFFI</b>
CE Certification		63AU4549	63AU4549
Heat Input	max/min kW	25.6/11.0	29.8/12.0
Heat Output	max/min kW		
Efficiency of Nominal Heat Input	%	92.9	93.5
Efficiency at 30% of Nominal Heat Input	%	91.1	90.7
Heat Loss to the Casing ( $\Delta T=50^{\circ}\text{C}$ )	%	1.0	0.2
Flue Heat Loss with Burner Operating	%	6.1	6.3
Flue Heat Loss with Burner Off	%	0.4	0.4
Maximum Discharge of Fumes (G20)	Kg/h	49.5	60
Residual Discharge Head	mbar	0.96	1.60
Consumption at Nominal Capacity(G20)	m <sup>3</sup> /h	2.72	3.15
Gas Consumption after 10 Minutes*	m <sup>3</sup>	0.32/0.39	0.37
(15°C, 1013 mbar) (G30-G31)	Kg/h	2.02/2.00	2.34/2.31
Temp. of exhaust fumes at nominal capacity	°C	123	128.8
CO <sub>2</sub> Content	%	7.2	6.9
O <sub>2</sub> Content	%	7.5	8.1
CO Content	ppm	51.9	48
Minimum Ambient Temperature	°C	+5	+5
Head Loss on Water Side (max) ( $\Delta T=20^{\circ}\text{C}$ )	mbar	200	200
Residual Head of System	bar	0.25	0.25
Heating Temperature	max/min °C	82/42	82/42
Domestic Hot Water Temperature	max/min °C	56/36	56/36
D.H.W. Flow Rate $\Delta T=35^{\circ}\text{C}$	l/min	9.7	11.4
D.H.W. Flow Rate $\Delta T=35^{\circ}\text{C}$	gal/min	2.2	2.6
D.H.W. Minimum Flow Rate	l/min	2.6	2.6
Pressure of Domestic Hot Water	max/min bar	8/0.2	8/0.2
Expansion Vessel Capacity	l	6	6
Expansion Vessel Pre-load Pressure	bar	1	1
Maximum Water Content of System	l	130	130
Maximum Heating Pressure	bar	3	3
Nominal Pressure	Natural Gas (G20) mbar	20	20
	LPG (G30-G31) mbar	30-37	30-37
Electrical Supply	V/Hz	230 / 50	230 / 50
Power Consumption	W	140	155
Protection Grade of Electrical System	IP	X4D	X4D
Internal Fuse Rating		FAST 2 AT	FAST 2 AT
Weight	Kg	38	39
<b>G.C. Number</b>		<b>47-116-14</b>	<b>47-116-15</b>

\*Calculated at 70% maximum output

Manufacturer: **Merloni TermoSanitari SpA - Italy**

Commercial subsidiary: **MTS (GB) LIMITED**

MTS Building  
 Hughenden Avenue  
 High Wycombe  
 Bucks HP13 5FT  
 Telephone: (01494) 755600  
 Fax: (01494) 459775  
 internet: <http://www.mts.gb.ltd.uk>  
 E-mail: [info@mts.gb.ltd.uk](mailto:info@mts.gb.ltd.uk)  
**Technical Service Hot Line: (01494) 539579**



# Servicing Instructions

## Type C Boilers

G.C.N: 47-116-14

47-116-15

LEAVE THESE INSTRUCTIONS  
WITH THE END-USER



*The code of practice for the installation,  
commissioning & servicing of central heating systems*

# micro GENUS

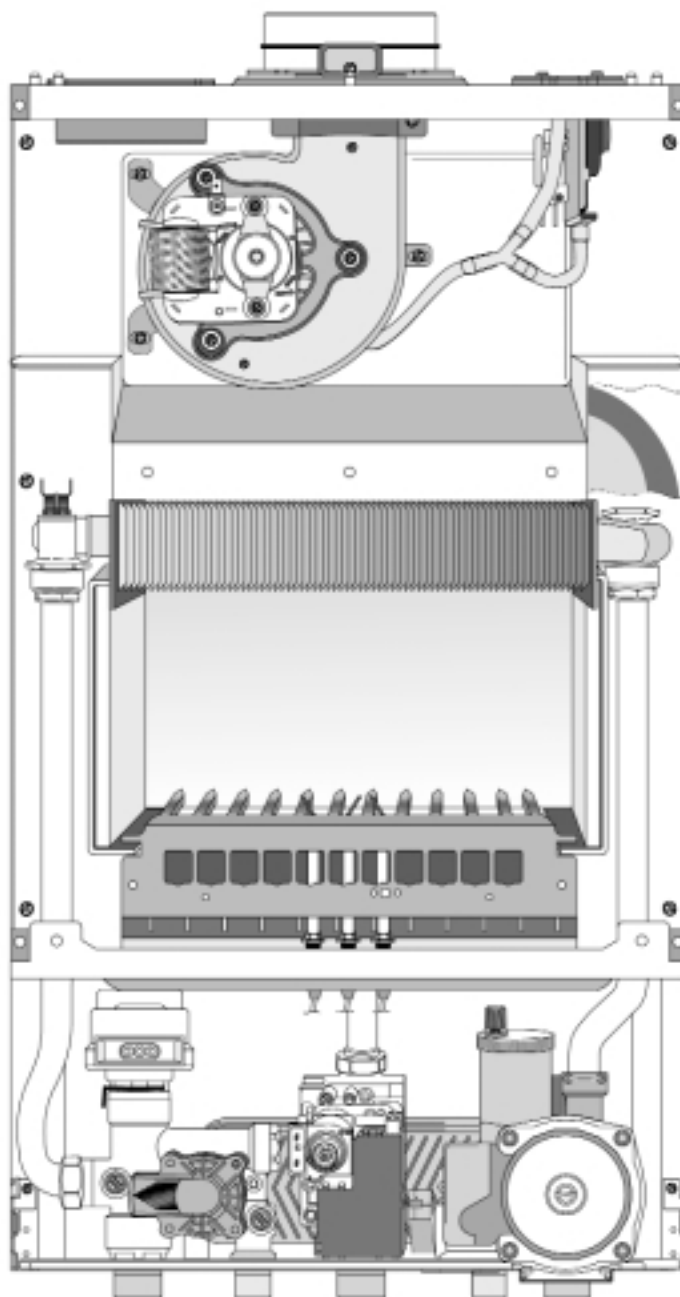

The Ariston logo, consisting of a stylized house icon followed by the word "ARISTON" in a bold, uppercase font.

# TABLE OF CONTENTS

1. **SERVICING INSTRUCTIONS**
  - 1.1 REPLACEMENT OF PARTS
  - 1.2 TO GAIN GENERAL ACCESS
    - *Removing the front panel*
    - *Removing the sealed chamber frontal cover*
    - *Removing the side panels*
  - 1.3 ACCESS TO THE COMBUSTION CHAMBER
    - *Removing the combustion cover*
    - *Removing the burner and jets*
    - *Removing the electrodes*
    - *Removing the main heat exchanger*
    - *Removing the air pressure switch*
    - *Removing the fan*
    - *Removing the venturi device*
  - 1.4 SERVICING AND REMOVAL OF THE GAS VALVE
    - *Setting the gas pressures*
    - *Removing the spark generator*
    - *Removing the gas valve*
  - 1.5 ACCESS TO THE WATER CIRCUIT
    - *Removing the D.H.W. (secondary) exchanger*
    - *Removing the safety valve*
    - *Removing the automatic air vent*
    - *Removing the main circuit flow switch*
    - *Removing the pump*
    - *Removing the pressure gauge*
    - *Removing the expansion vessel*
    - *Removing the overheat thermostat*
    - *Removing the heating temperature sensor (N.T.C.)*
    - *Removing the D.H.W. temperature sensor (N.T.C.)*
    - *Removing the divertor valve actuator*
    - *Removing the D.H.W. flow switch*
  - 1.6 ACCESS TO THE CONTROL SYSTEM
    - *Checking the fuses*
    - *Removing the time clock*
    - *Removing the P.C.B.*
2. **FAULT FINDING**
  - 2.1 FAULT FINDING GUIDE (FLOW-CHART)
3. **ELECTRICAL DIAGRAMS**
4. **SHORT SPARE PARTS LIST**

# 1. SERVICING INSTRUCTIONS

To ensure efficient safe operation, it is recommended that the boiler is serviced annually by a competent person.

**Before starting any servicing work, ensure both the gas and electrical supplies to the boiler are isolated and the boiler is cool.**

Before and after servicing, a combustion analysis should be made via the flue sampling point (please refer to the Installation Manual for further details).

After servicing, preliminary electrical system checks must be carried out to ensure electrical safety (i.e. polarity, earth continuity, resistance to earth and short circuit).

## 1.1 REPLACEMENT OF PARTS

The life of individual components varies and they will need servicing or replacing as and when faults develop.

The fault finding sequence chart in chapter 2 will help to locate which component is the cause of any malfunction, and instructions for removal, inspection and replacement of the individual parts are given in the following pages.

## 1.2 TO GAIN GENERAL ACCESS

All testing and maintenance operations on the boiler require the control panel to be lowered. This will also require the removal of the casing.

### Removing the front panel

1. Loosen the fastening screws "A" of the control panel located on the lower part of the panel itself. (FIG. 1.1);

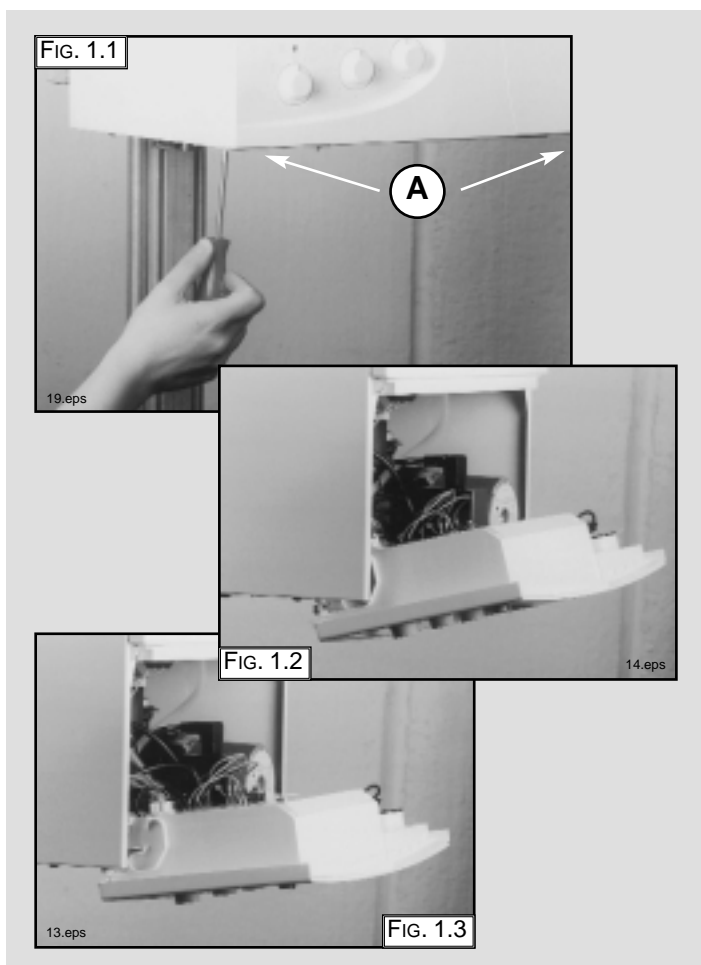

2. The control panel moves downward and when pulled forward, rotates on two lateral hinges; the panel stays in a semi-horizontal position, which allows access to the inner parts of the boiler (FIG. 1.2);
3. In order to increase the manouvering space, it is possible to raise the control panel and rotate it to a fully horizontal position (FIG. 1.3);
4. Remove the screws "B" from the front panel bottom lip (FIG. 1.4);
5. Lift the front panel from the raised screws at the the top of the casing (FIG. 1.5).



### Removing the sealed chamber frontal cover

1. Remove the screws "C" (FIG. 1.6);
2. Lift the sealed chamber frontal cover from the locating pins (FIG. 1.7).

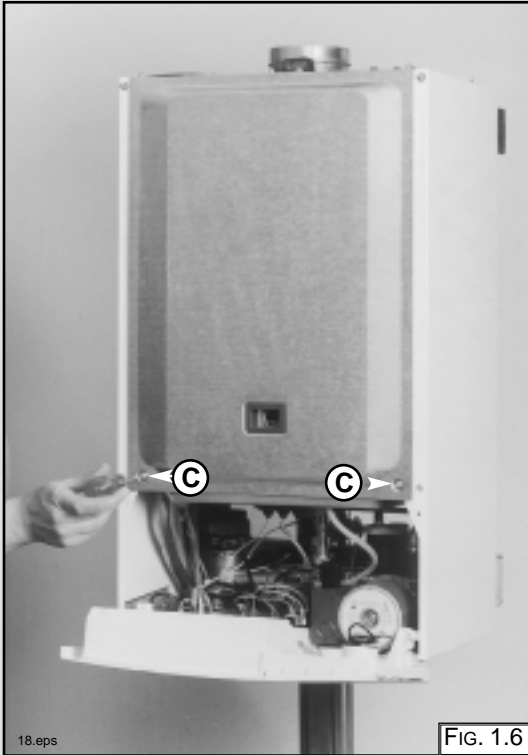

### Removing the side panels

1. Remove the four screws "D" for each side panel (FIG.1.8);
2. Pull the panel away from the boiler, then lift the panel up and remove from the boiler (FIG.1.9).

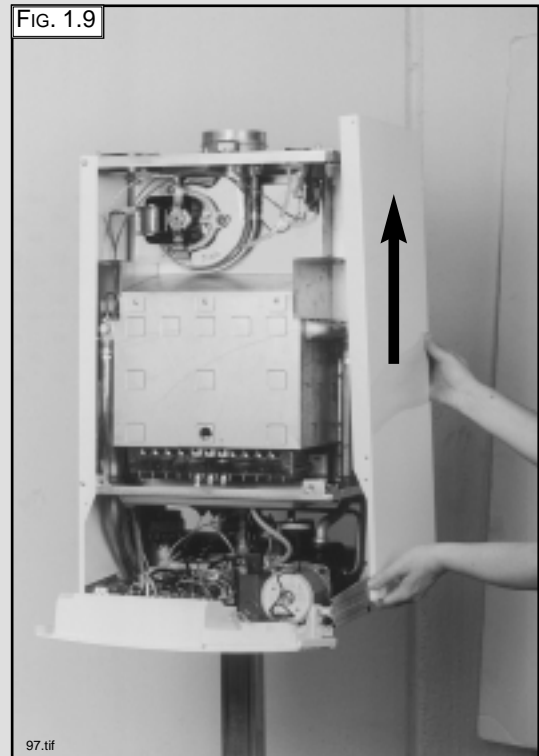
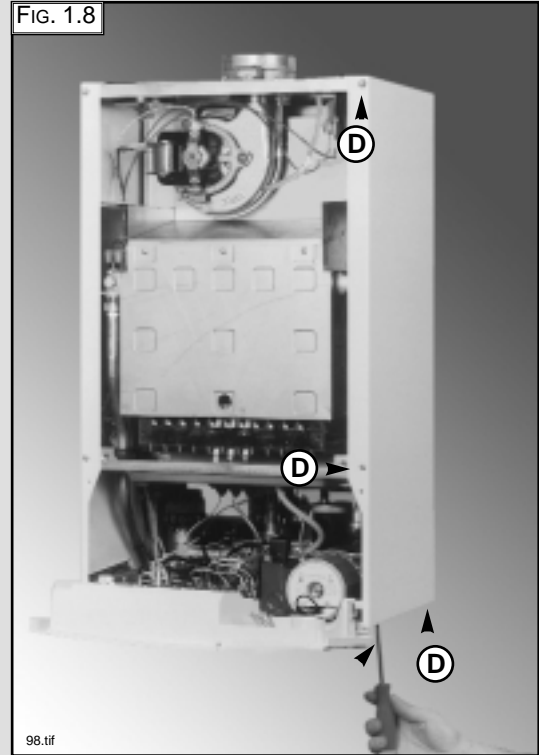

### 1.3 ACCESS TO THE COMBUSTION CHAMBER

#### Removing the combustion cover

1. Remove the screws "E" (FIG. 1.10);
2. Lift off the combustion cover.

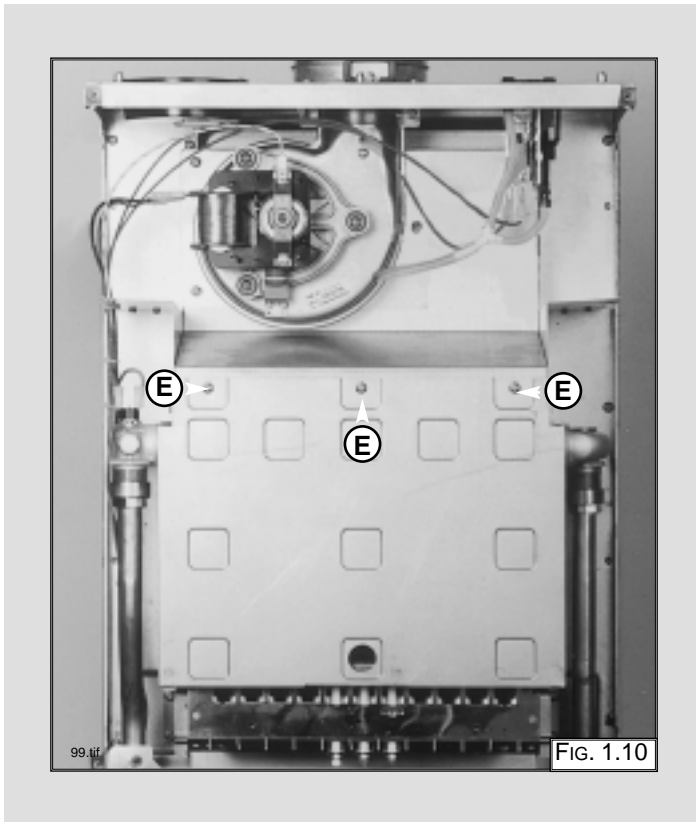

#### Removing the burner and jets

1. Remove the screws "F" from the burner (FIG. 1.11);
2. Remove the burner (FIG. 1.12);
3. Remove the jets using a No. 7 socket spanner;
4. Replace in reverse order.

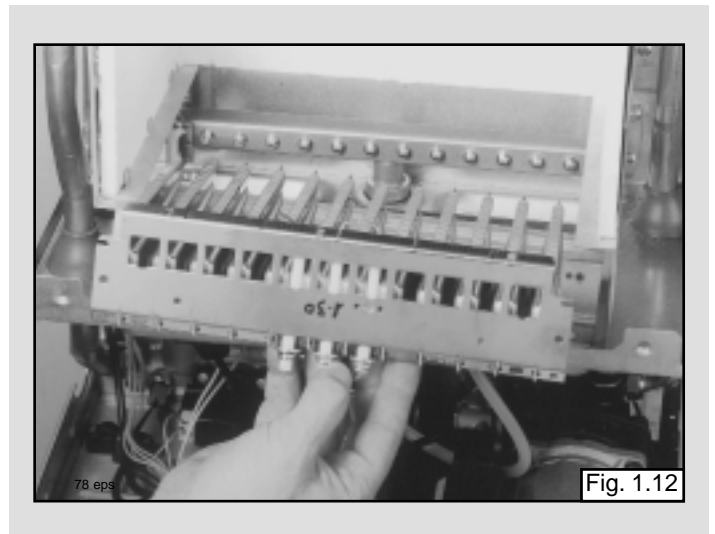
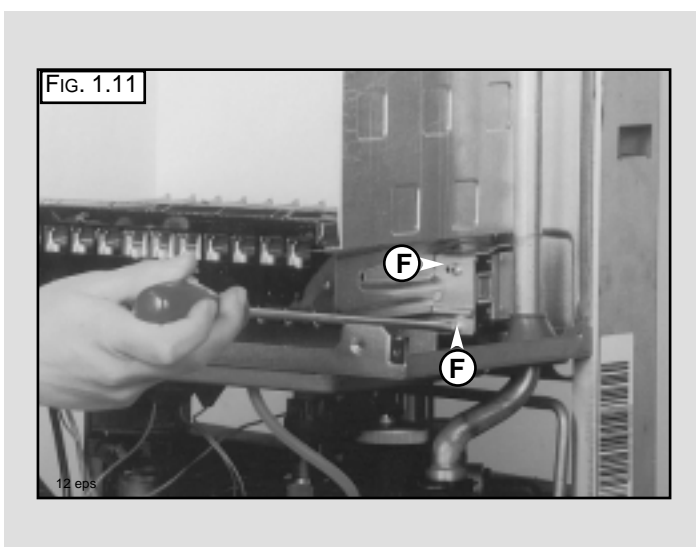

#### Removing the electrodes

Before carrying out this procedure, unscrew and slide the burner forward (see previous section).

1. Remove rubber gasket "G" (FIG. 1.13);
2. To remove the detection electrode disconnect the cable at its connection point close to the P.C.B. (FIG. 1.14);

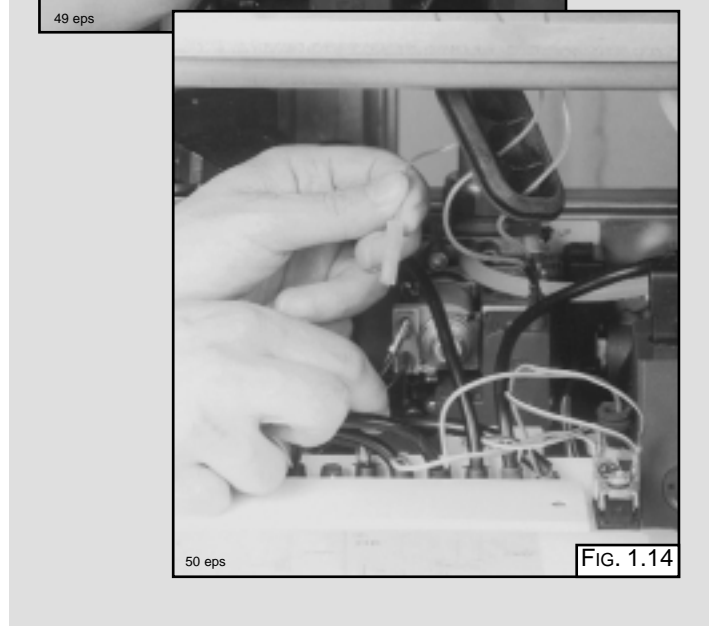
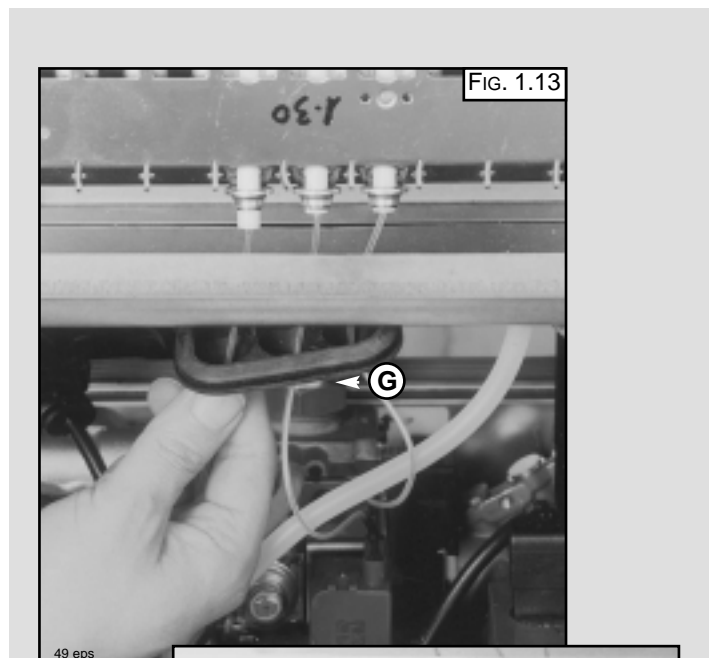

3. Remove screw "H" (FIG. 1.15);
4. Gently slide the electrode downward (FIG. 1.16).

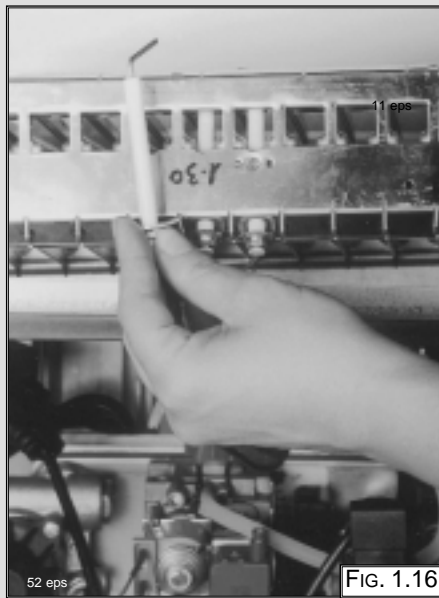
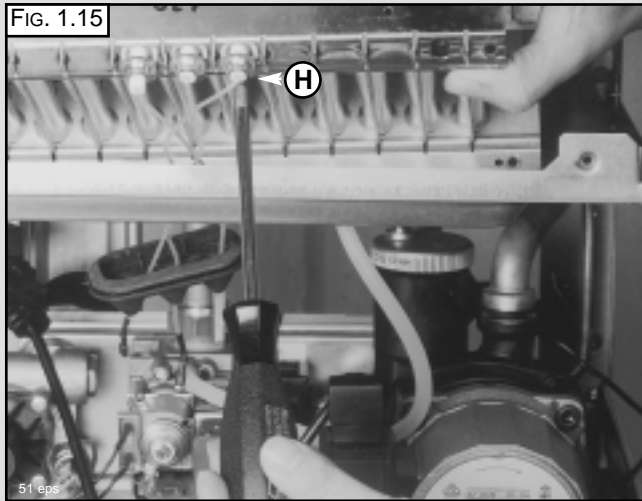

### Removing the main heat exchanger

1. Drain the boiler of water;
2. Release the overheat thermostat sensor "I" (FIG. 1.17);
3. Release the two connection nuts "J" connecting the exchanger to the flow and return pipes (FIG. 1.18);
4. Pull it straight out (FIG. 1.19).

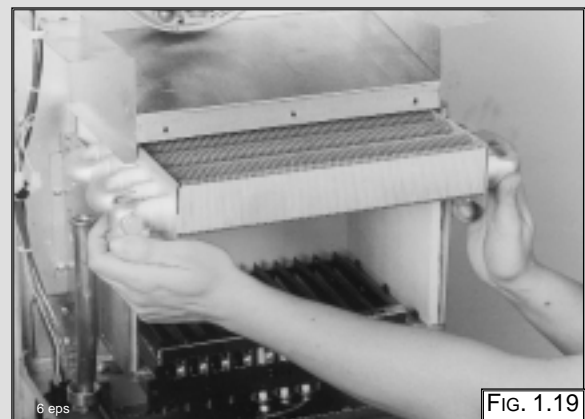
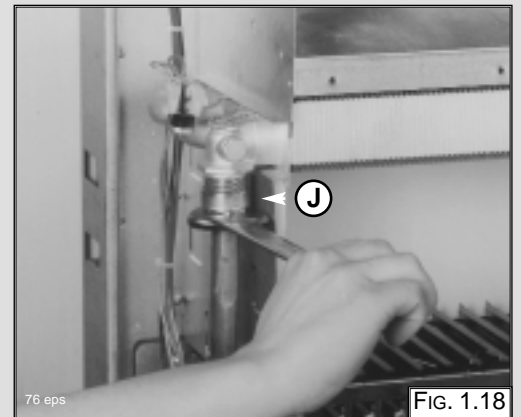
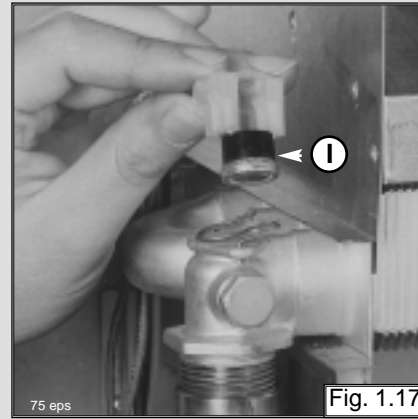

To replace, repeat the steps in reverse order, paying particular attention to the following:

- a** - Centre the electrode in the positioning hole carefully, otherwise the electrode may break;
- b** - Check that the cables have been connected correctly;
- c** - Check that the rubber gasket covers the cable/ electrode connection point completely.

### Removing the air pressure switch

1. Disconnect the electrical connections "K" and silicon pipes "L" from their connection points (FIG. 1.20);
2. Remove screws "M" on the top of the sealed chamber (FIG. 1.21);
3. Unscrew to remove switch from the plate (FIG. 1.22).

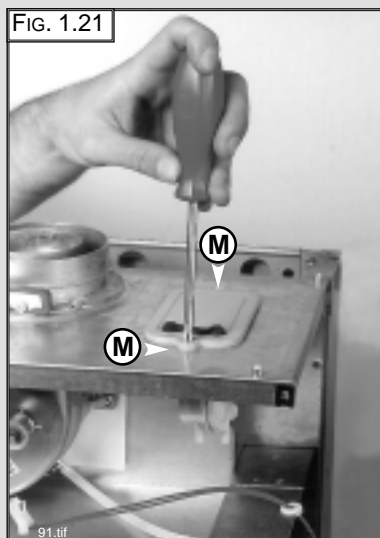
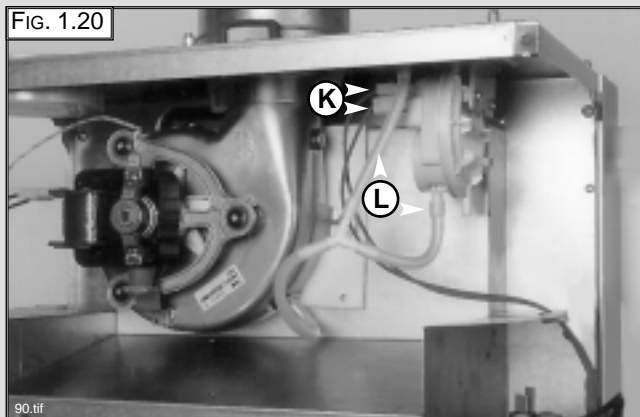

### Removing the fan

1. Disconnect electrical connections "N" and silicon pipes "O" (FIG.1.23);
2. Remove screw "P" and remove the fan collar clamp "Q" (FIG.1.24);
3. Remove screws "R" (FIG.1.25);
4. Remove fan and mounting plate (FIG.1.26).

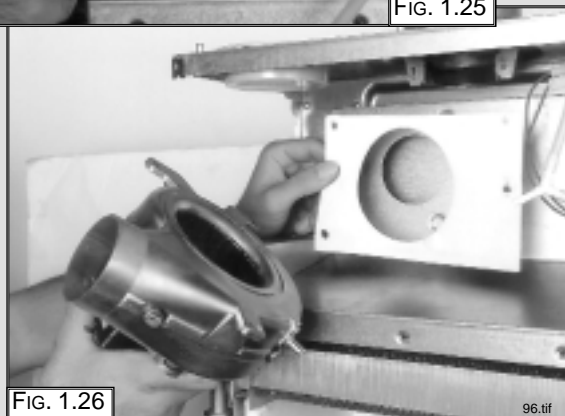
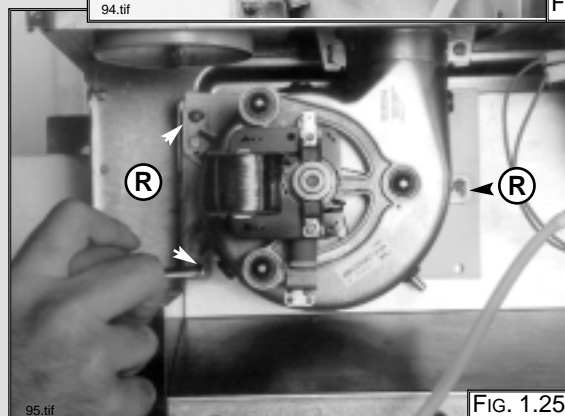
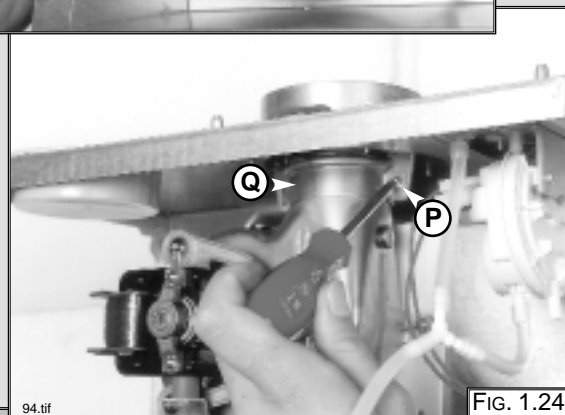
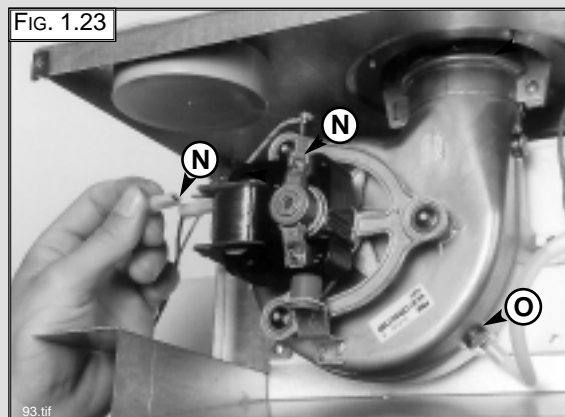

## 1.4 SERVICING AND REMOVAL OF THE GAS VALVE

### Setting the gas pressures

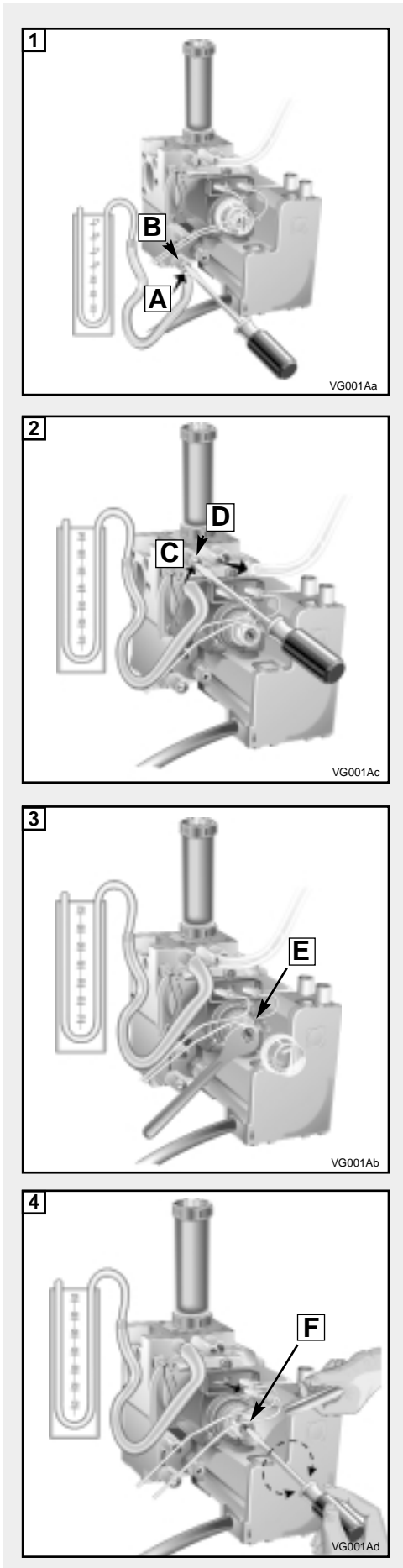

### Setting the minimum and the maximum power of the boiler

1. Check that the supply pressure to the gas valve is a minimum of 20 mbar for natural gas.
2. To do this, remove the screw "A".  
Fit the pipe of the pressure gauge to the pressure connection of the gas valve "B".  
When you have completed this operation, replace the screw "A" securely into its housing to seal off the gas.
3. To check the pressure supplied by the gas valve to the burner, remove the screw "C". Fit the pipe of the pressure gauge to the pressure outlet of the gas valve "D".  
Disconnect the compensation pipe either from the gas valve or from the sealed chamber.
4. Set the On/Off button to position < ① > and the "summer/winter" switch to the winter position.  
To set the maximum power, turn on the hot water tap and allow the hot water tap to run at a rate of about 8 litres/minute so that the main burner lights.  
Adjust nut "E" on the modereg to set the gas pressure (displayed on the pressure gauge) corresponding to the maximum power (see TABLE "A" page 9).
5. To set the minimum power, disconnect a supply terminal from the modereg and adjust screw "F".  
Turn the screw clockwise to increase the pressure and counter-clockwise to decrease the pressure (displayed on the pressure gauge) corresponding to the minimum power (see TABLE "A" page 9).
6. When you have completed the above operations, turn off the hot water tap, re-connect the supply terminal to the modereg on the gas valve and replace the cap on the screw of the modereg.

### Setting the maximum heating circuit power

7. To set the maximum heating circuit power, place the On/Off button to position < ① > and the "summer/winter" switch to winter position.  
Turn the knob of the heating thermostat clockwise to maximum.
8. Remove the inspection panel of the P.C.B. and fit a small cross-head screwdriver in to the right hand potentiometer. Turn clockwise to increase the pressure or counter-clockwise to reduce the pressure. Adjust the setting to the required heating pressure value (displayed on the pressure gauge), as indicated in the diagrams shown in page 10.
9. Turn off the boiler by placing the main switch to the "Off" position.

### Setting pressure for soft ignition.

Disconnect the detection electrode connection from the P.C.B..

Start the boiler and during the ignition sequence adjust the left hand potentiometer until the gas pressure reads the required gas pressure as per the table below.

Once the gas pressure is set turn off the boiler and re-connect the connection to the P.C.B.

NB.: It may be necessary to reset the flame failure reset a number of times during this operation.

	NATURAL GAS (G20)	BUTANE GAS (G30)	PROPANE GAS (G31)
Recommended pressure for soft-light ignition	8 mbar	16 mbar	16 mbar



**Regulating the heating power for natural gas (G20)**

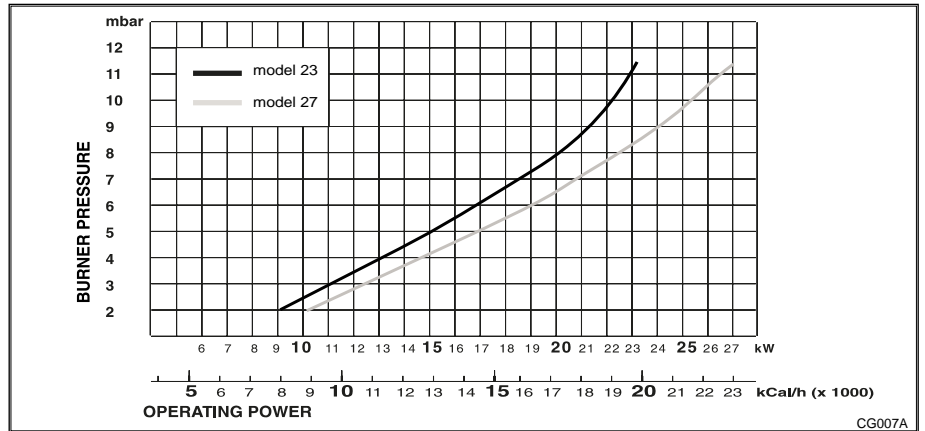

**Regulating the heating power for butane gas (G30)**

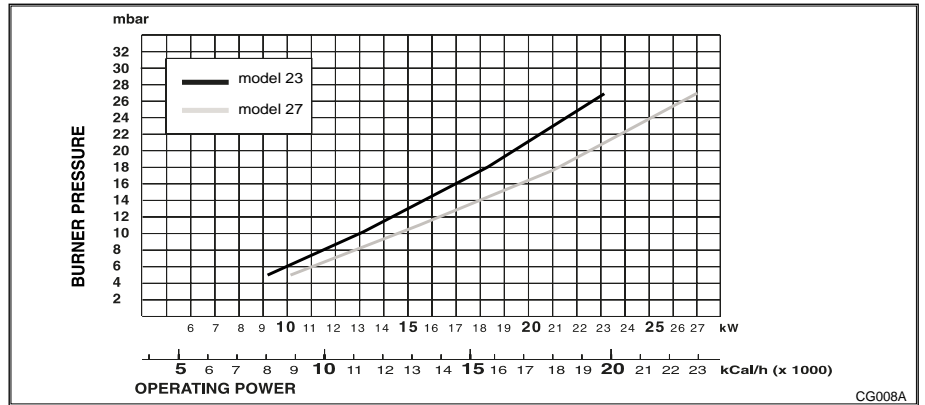

**Regulating the heating power for propane gas (G31)**

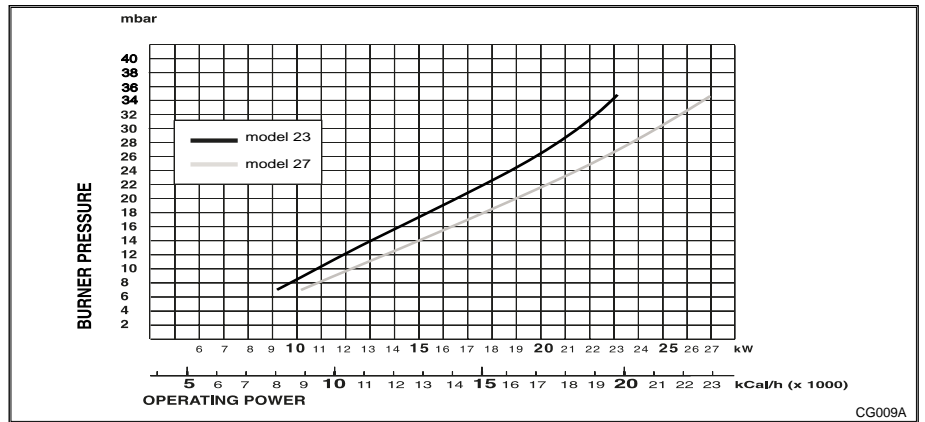

**TABLE "A"**

<b>mife GENUS 23 MFFI</b>	<b>GAS REQUIREMENTS</b>		<b>NATURAL GAS (G20)</b>	<b>BUTANE GAS (G30)</b>	<b>PROPANE GAS (G31)</b>
	Gas rate	max	2.70 m <sup>3</sup> /h	2.01 Kg/h	2.00 Kg/h
	Gas rate	min	1.16 m <sup>3</sup> /h	0.87 Kg/h	0.85 Kg/h
	Inlet pressure		20 mbar	28 mbar	37 mbar
	Burner pressure	max	11.0 mbar	27.7 mbar	35.5 mbar
	Burner pressure	min	2.0 mbar	6.0 mbar	7.3 mbar
	Burner jets		12 x 1.30	12 x 0.77	12 x 0.77
<b>mife GENUS 27 MFFI</b>	<b>GAS REQUIREMENTS</b>		<b>NATURAL GAS (G20)</b>	<b>BUTANE GAS (G30)</b>	<b>PROPANE GAS (G31)</b>
	Gas rate	max	3.15 m <sup>3</sup> /h	2.34 Kg/h	2.31 Kg/h
	Gas rate	min	1.26 m <sup>3</sup> /h	0.94 Kg/h	0.93 Kg/h
	Inlet pressure		20 mbar	28 mbar	37 mbar
	Burner pressure	max	11.0 mbar	27.7 mbar	35.5 mbar
	Burner pressure	min	1.6 mbar	4.6 mbar	6.0 mbar
	Burner jets		14 x 1.30	14 x 0.77	14 x 0.77

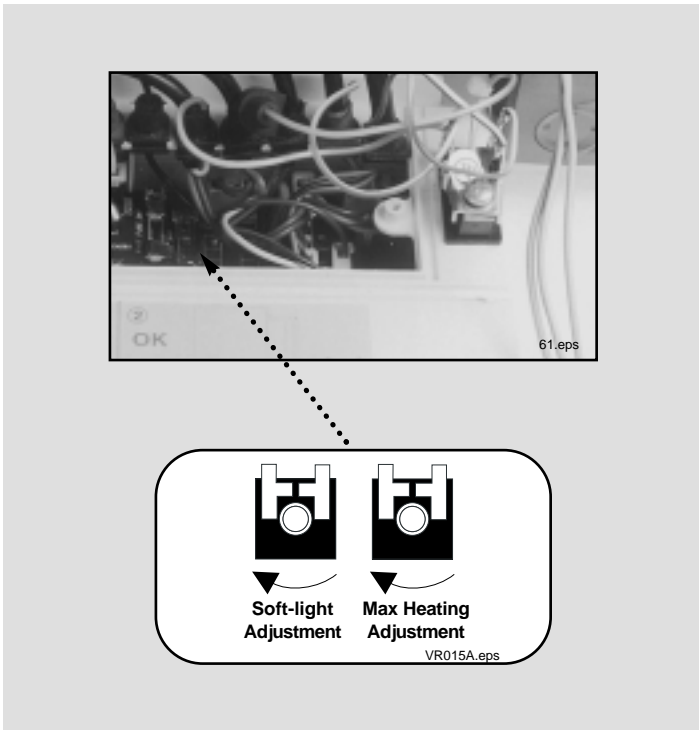

10. Remove the pipe from the pressure gauge and connect screw "C" to the pressure outlet in order to seal off the gas.
11. Carefully check the pressure outlets for gas leaks (valve inlet and outlet).

**IMPORTANT!**

Whenever you disassemble and reassemble the gas connections, always check for leaks using a soap and water solution.

**Removing the spark generator**

1. Disconnect ignition leads "T" by pulling upward (FIG. 1.27);
2. Remove the screw "V" (FIG. 1.28);
3. Remove the spark generator (FIG. 1.29).

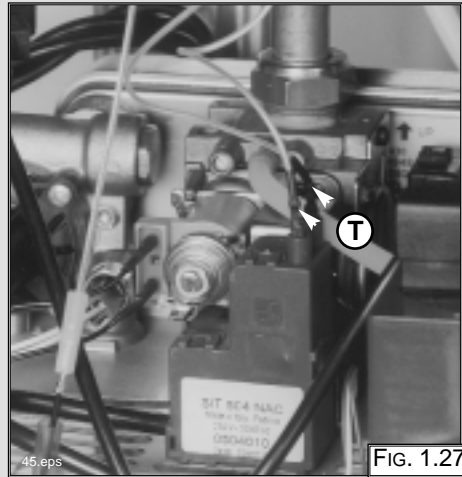

FIG. 1.27

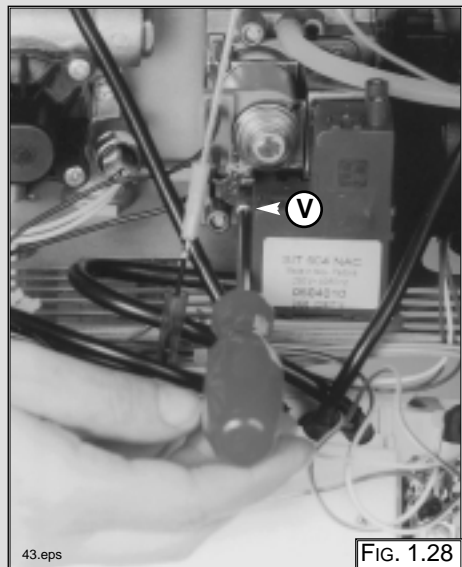

FIG. 1.28



FIG. 1.29

## Removing the gas valve

1. Disconnect all the cables from the solenoid and modureg;
2. Remove the spark generator (see previous section);
3. Release the top nut "W" (FIG. 1.30);
4. Remove the screws "X" from the bottom of the gas valve pipe (FIG. 1.31);
5. Remove the gas valve (FIG. 1.32).

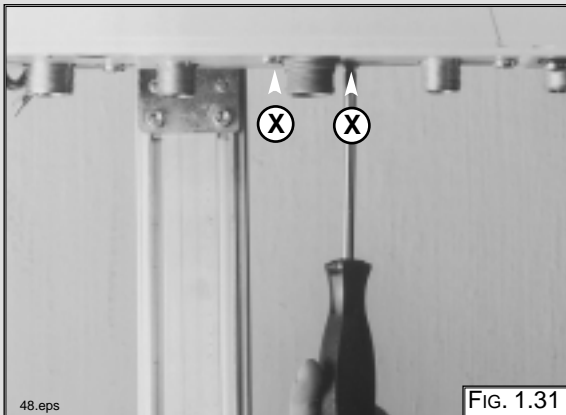
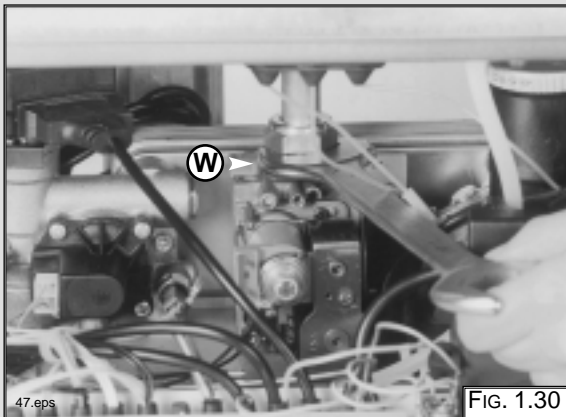

## 1.6 ACCESS TO THE WATER CIRCUIT

**Important!** Before any component is removed, the boiler must be drained of all water.

### Removing the D.H.W. (secondary) exchanger

1. Remove the screws "Y" (FIG 1.33 + FIG 1.34);
2. Push the exchanger towards the rear of the boiler, and lift upwards and remove out of the front of the boiler (FIG 1.35);
3. Before replacing the exchanger ensure that the O-rings are in good condition and replace if necessary.

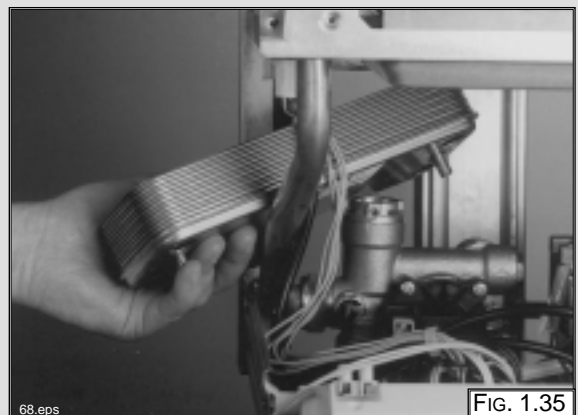
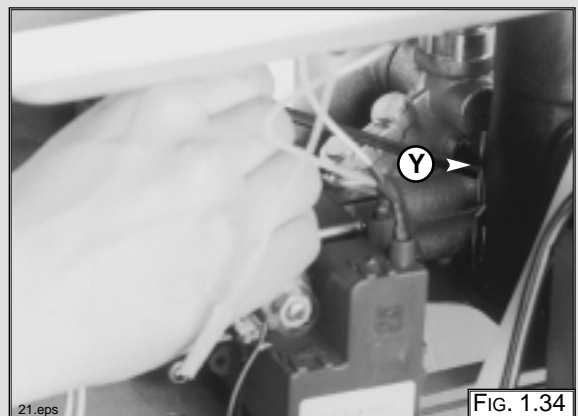
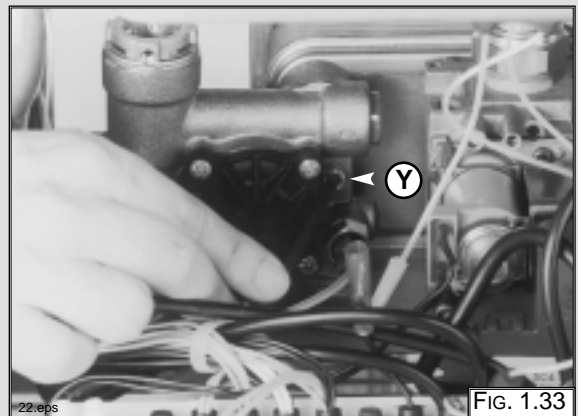

### Removing the safety valve

1. Loosen nut "Z" (FIG. 1.36);
2. Unscrew and remove the valve (FIG. 1.37).

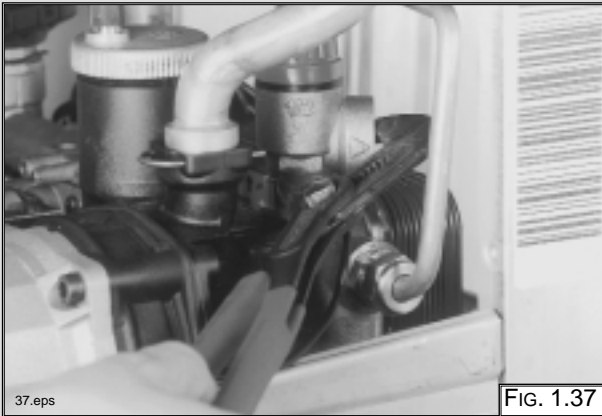
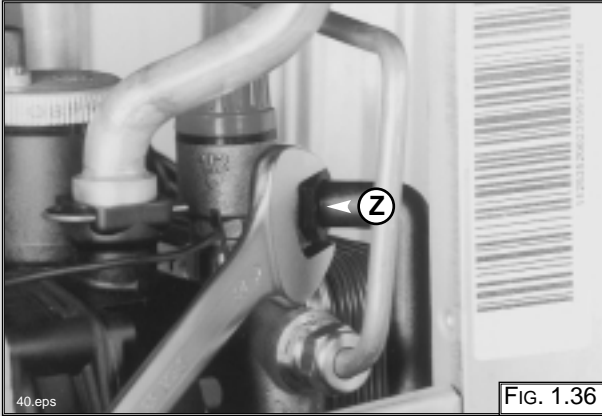

### Removing the automatic air vent

1. Unscrew valve top "A1" (FIG. 1.38);
2. Remove valve (FIG 1.39).

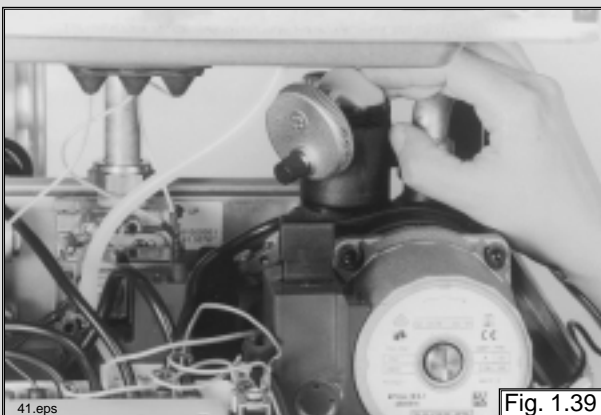
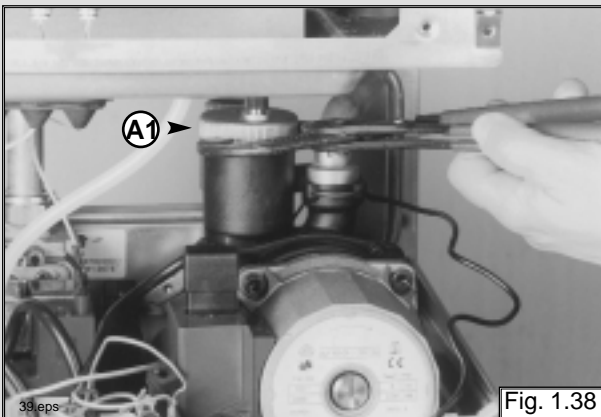

### Removing the main circuit flow switch

1. Remove the cable of the main circuit flow switch "B1" (FIG. 1.40);
2. Remove the screws "C1" (FIG. 1.41);
3. Remove the main circuit flow switch.

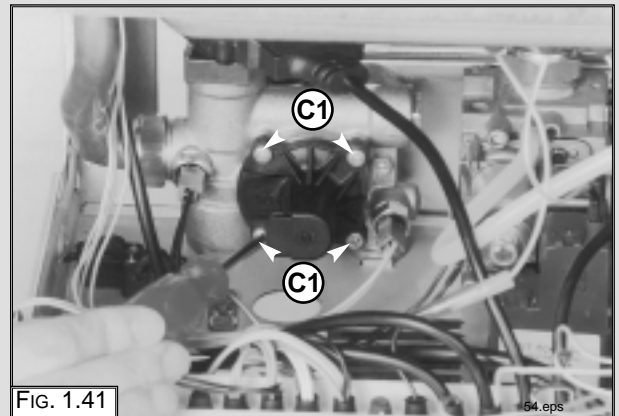
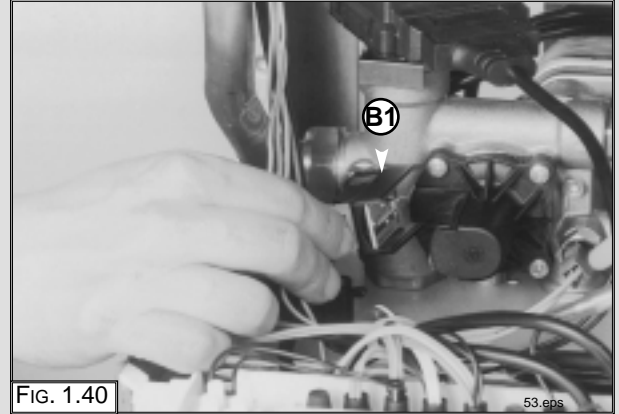

## Removing the pump

1. Remove the U-clip " D1" (FIG. 1.41);
2. Remove the retaining clip "E1" (FIG. 1.42);
3. Remove the U-clip " F1" (FIG. 1.43);
4. Release the nut "G1" (FIG. 1.44);
5. Remove the pipe "H1" (FIG. 1.45);
6. Remove the screws "I1" (FIG. 1.46);
7. Remove the pump (FIG. 1.47).

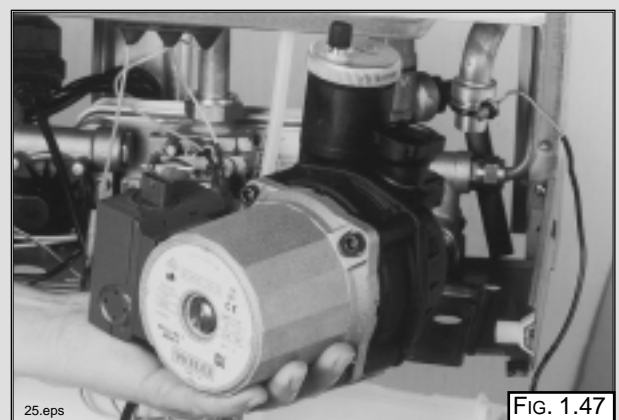
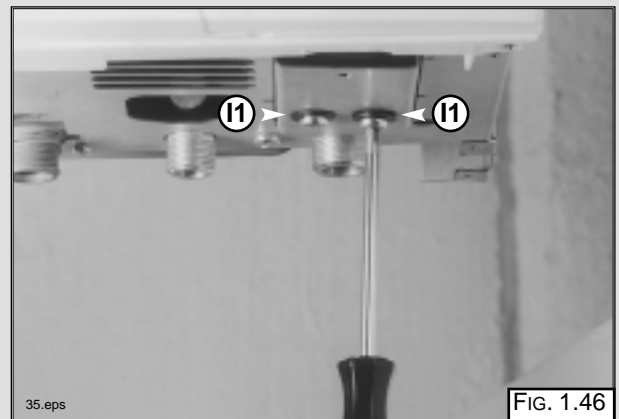
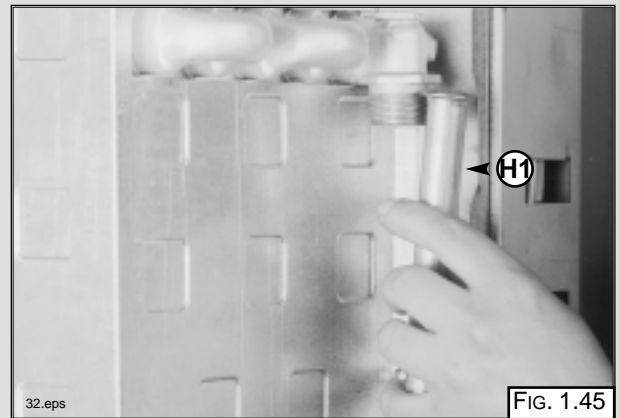
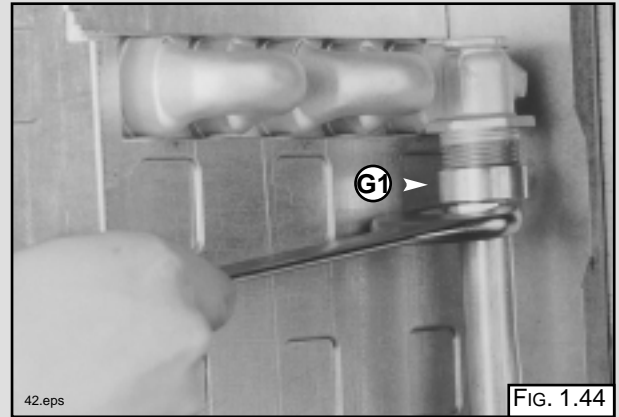
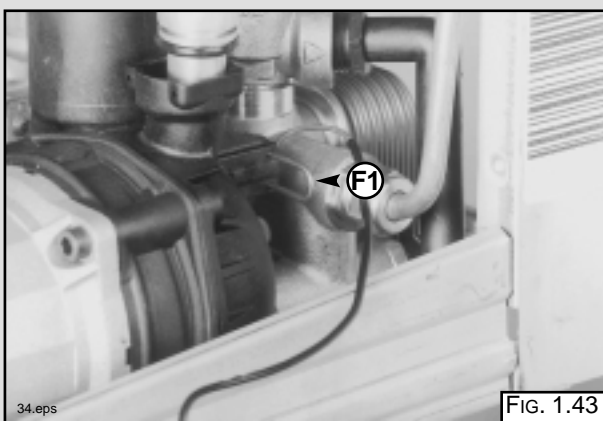
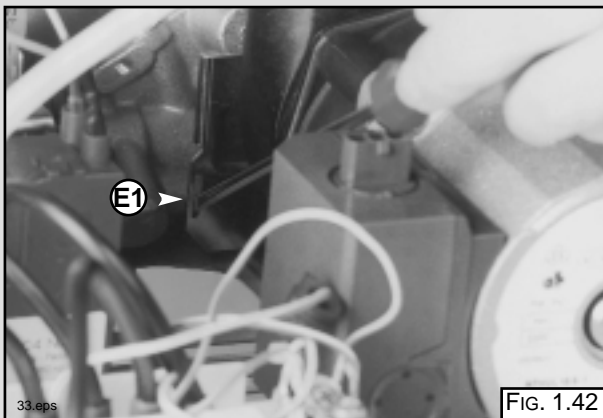
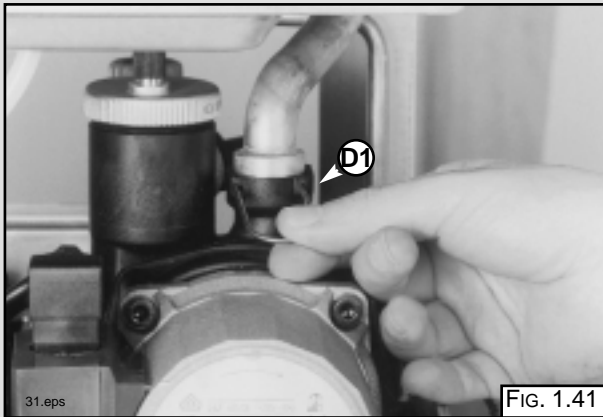

## Removing the pressure gauge

1. Remove the U-clip "J1" and remove the pressure gauge coupling (FIG. 1.48);
2. Push the pressure gauge through the control panel from the rear (FIG. 1.49).

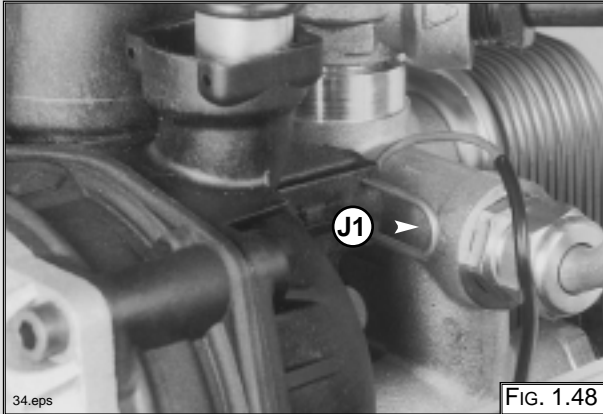

## Removing the expansion vessel

1. Loosen nuts "K1" and remove the gas pipe (FIG. 1.50);
2. Loosen nut "L1" (FIG. 1.51);
3. Remove back nut "M1" (FIG. 1.52);
4. Remove the expansion vessel (FIG. 1.53).

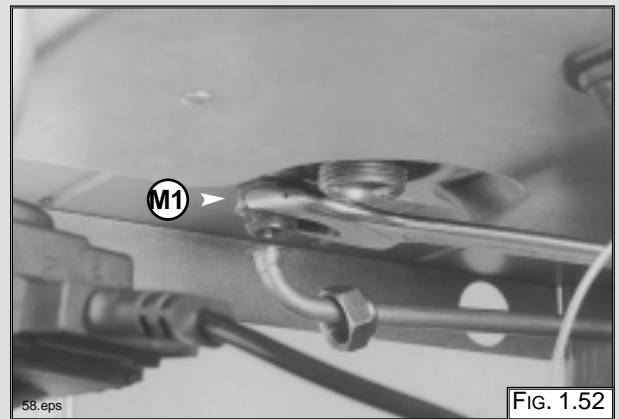
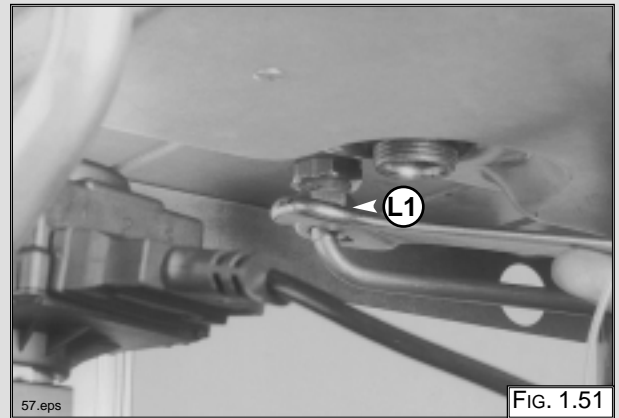
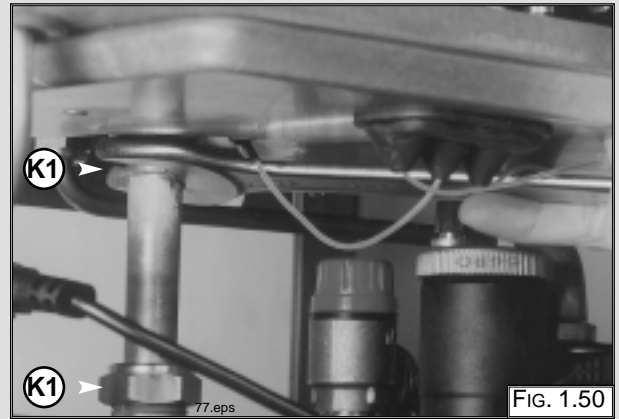

### Removing the overheat thermostat

1. Disconnect the overheat thermostat electrical connections "N1" (FIG. 1.54);
2. Then remove the thermostat from its mounting by releasing the securing clip (FIG. 1.55).

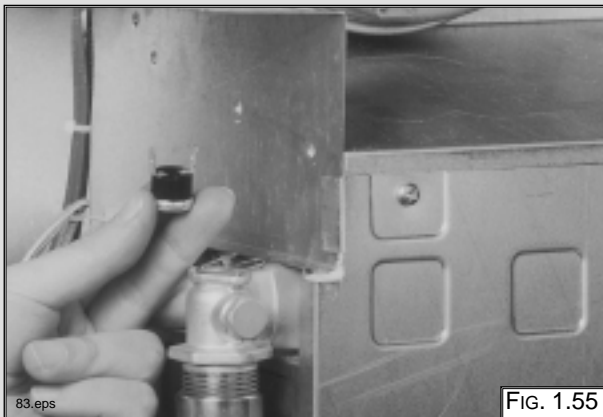
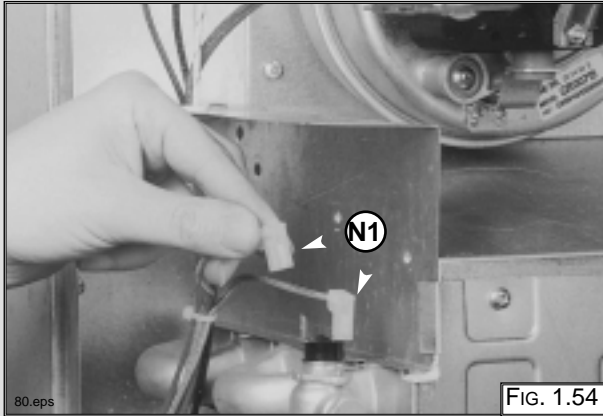

### Removing the heating temperature sensor (N.T.C.)

1. Pull off the electrical connector "P1" and unscrew the sensor probe using a suitable spanner (FIG. 1.56).

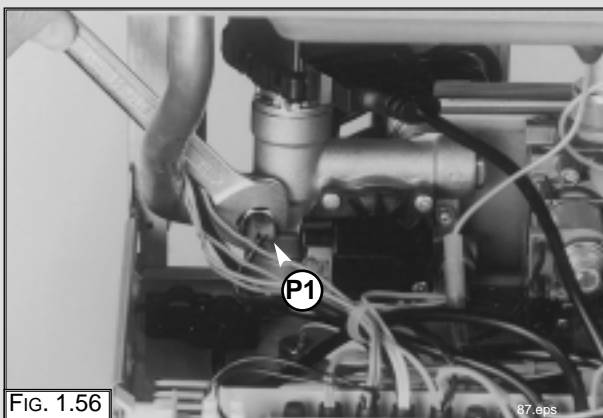

### Removing the D.H.W. temperature sensor (N.T.C.)

1. Pull off the electrical connector "Q1" and unscrew the sensor probe using a suitable spanner (FIG. 1.57).

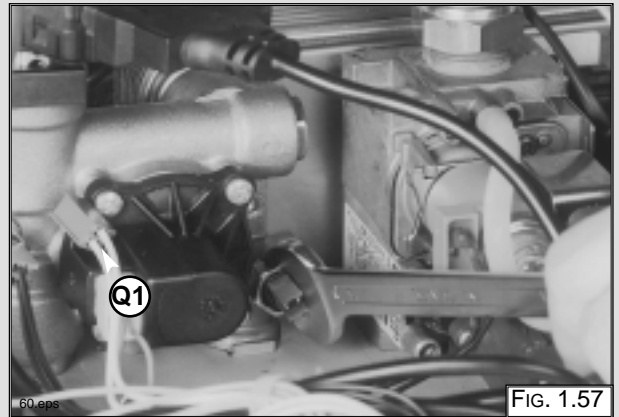

### Removing the diverter valve actuator

1. Unplug the electrical connector "R1" (FIG. 1.58);
2. Release the retaining clip "S1" and remove the diverter valve actuator.

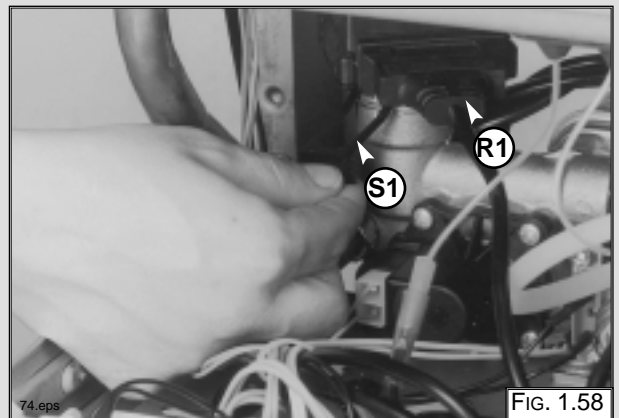

### Removing the D.H.W. flow switch

1. Unplug the electrical connector "T1" (FIG. 1.59);
2. Release the retaining clip "V1" and remove the D.H.W. flow switch.

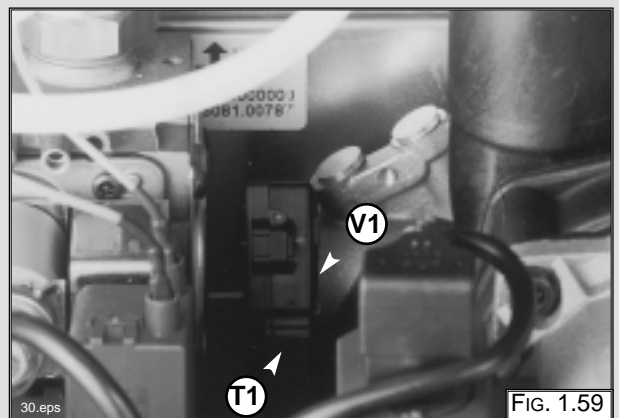



## 1.6 ACCESS TO THE CONTROL SYSTEM

### Checking the fuses

1. Remove the inspection cover on the reverse of the control panel (FIG. 1.60);
2. Remove the fuses (FIG. 1.61).

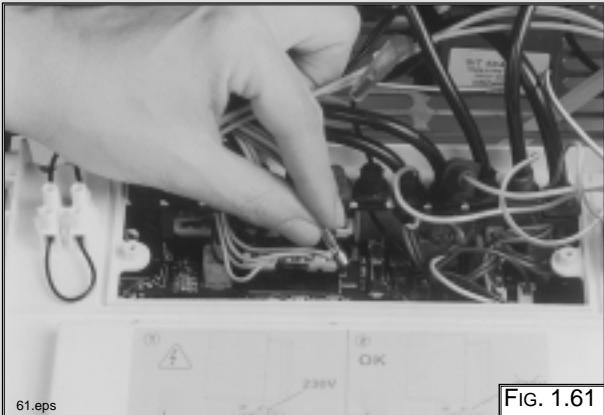
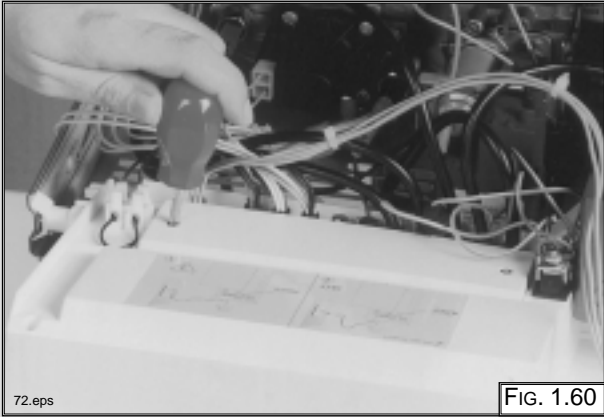

### Removing the time clock

1. Unplug electrical connection "W1" from the clock (FIG. 1.62);
2. Remove the screws "W2" (see fig. 1.63);
3. Remove the clock from the panel (see fig. 1.64).

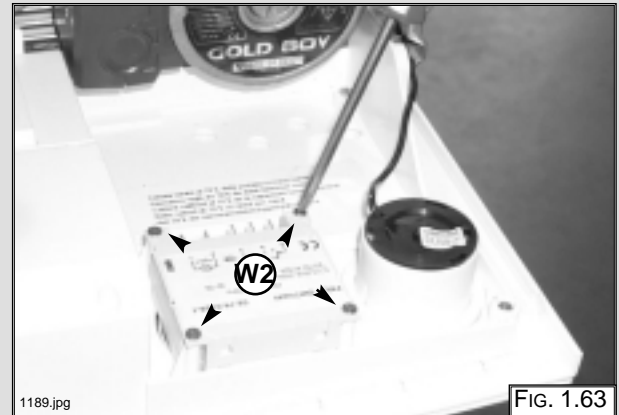



## Removing the P.C.B.

1. Isolate electricity;
2. Remove the inspection cover from the reverse of the control panel;
3. Unplug all electrical connections from the P.C.B. (FIG. 1.65);
4. Remove the screws "X1" (FIG. 1.66);
5. Separate the fascia panel from the rear of the control panel (FIG. 1.67);
7. Remove the screws "Y1" and remove the P.C.B. (FIG. 1.68).

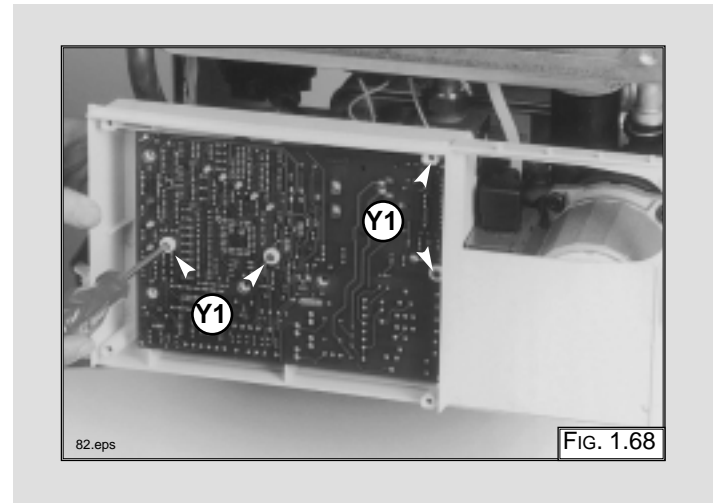
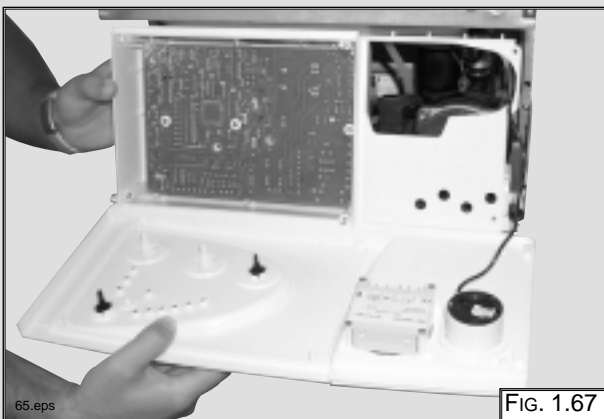
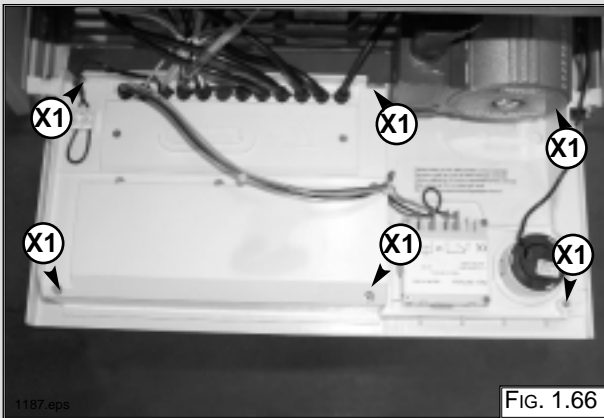
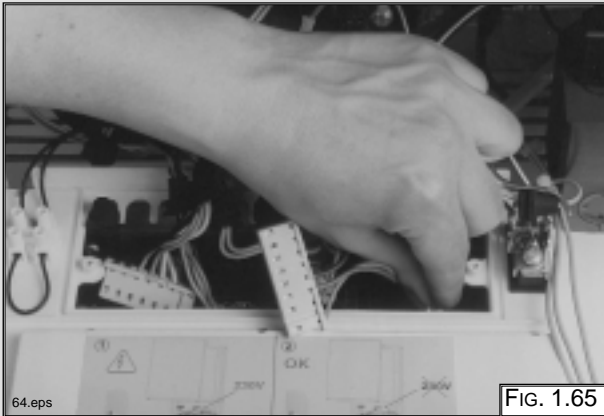

## 2. FAULT FINDING

### 2.1 FAULT FINDING GUIDE (FLOW-CHARTS)

It is possible to detect and correct any defect by using the standard fault finding diagrams described in this chapter.

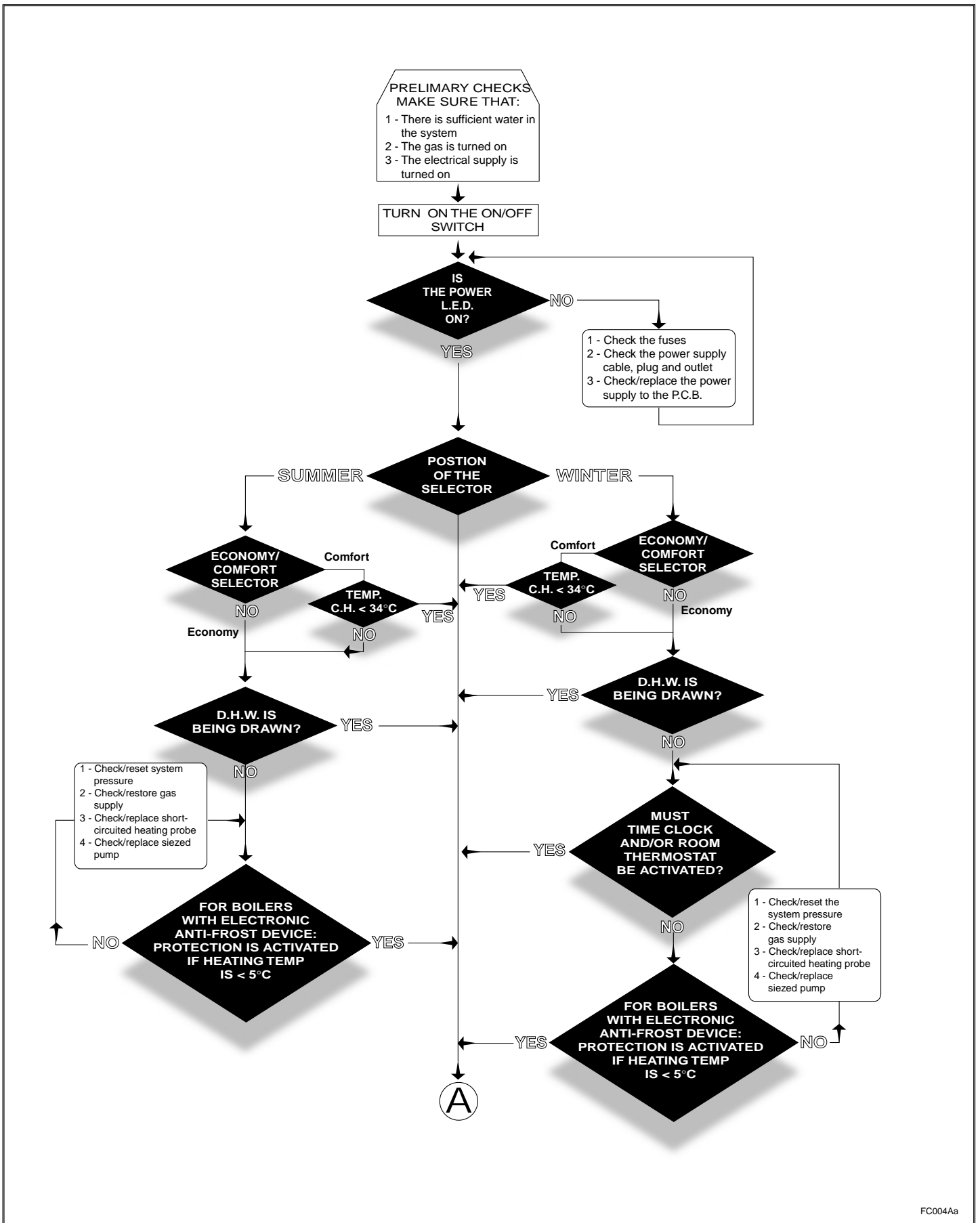

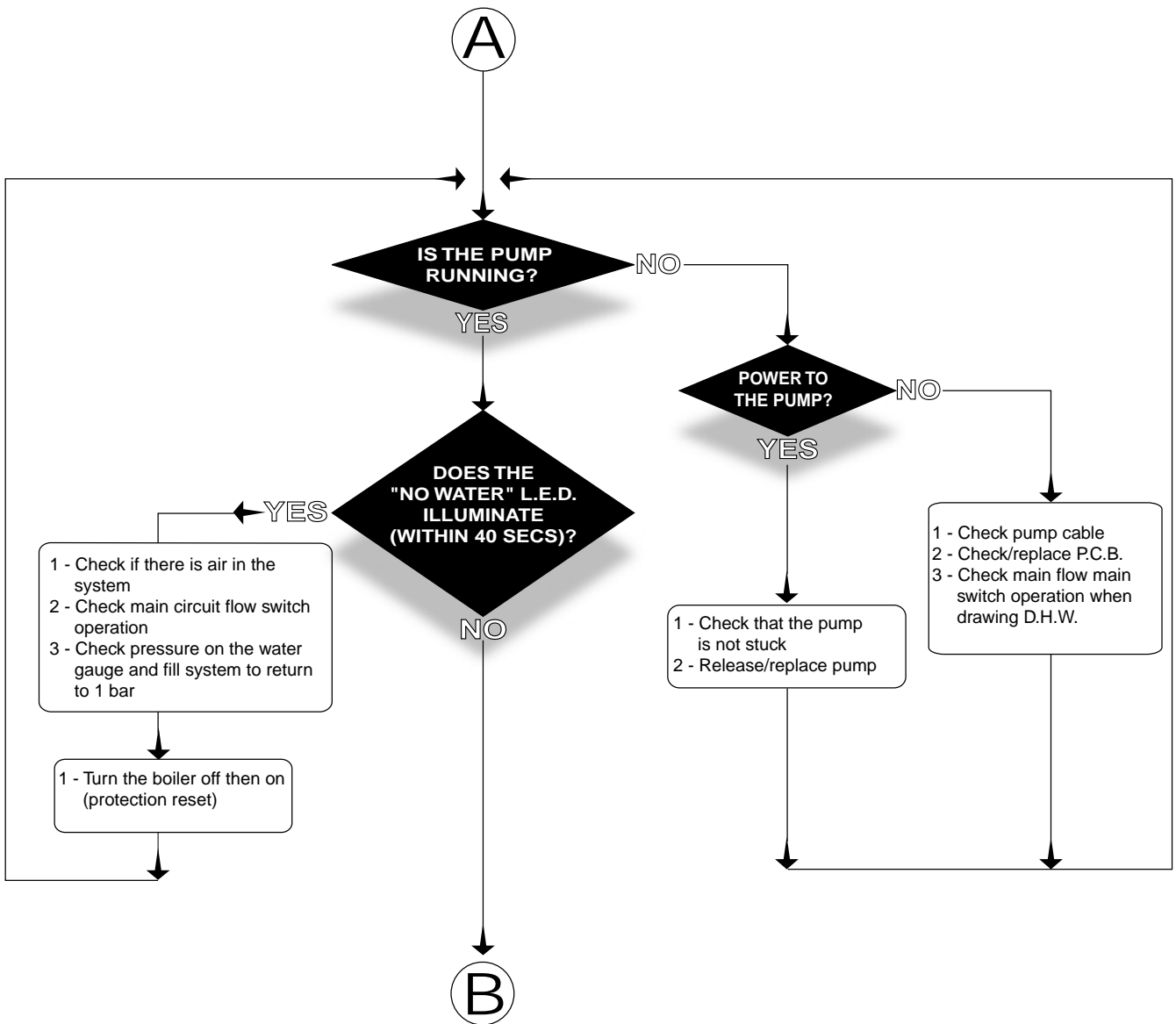

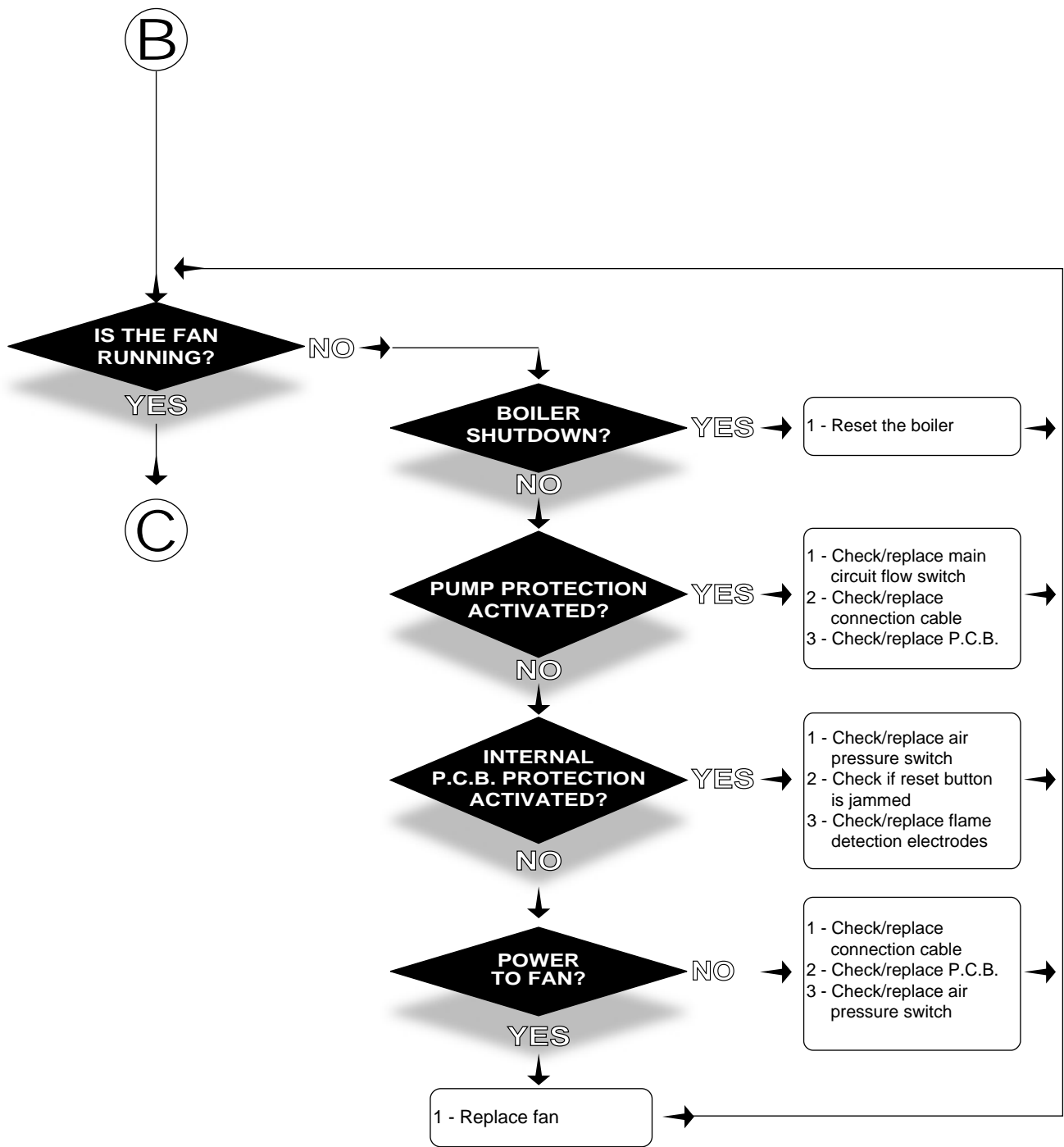

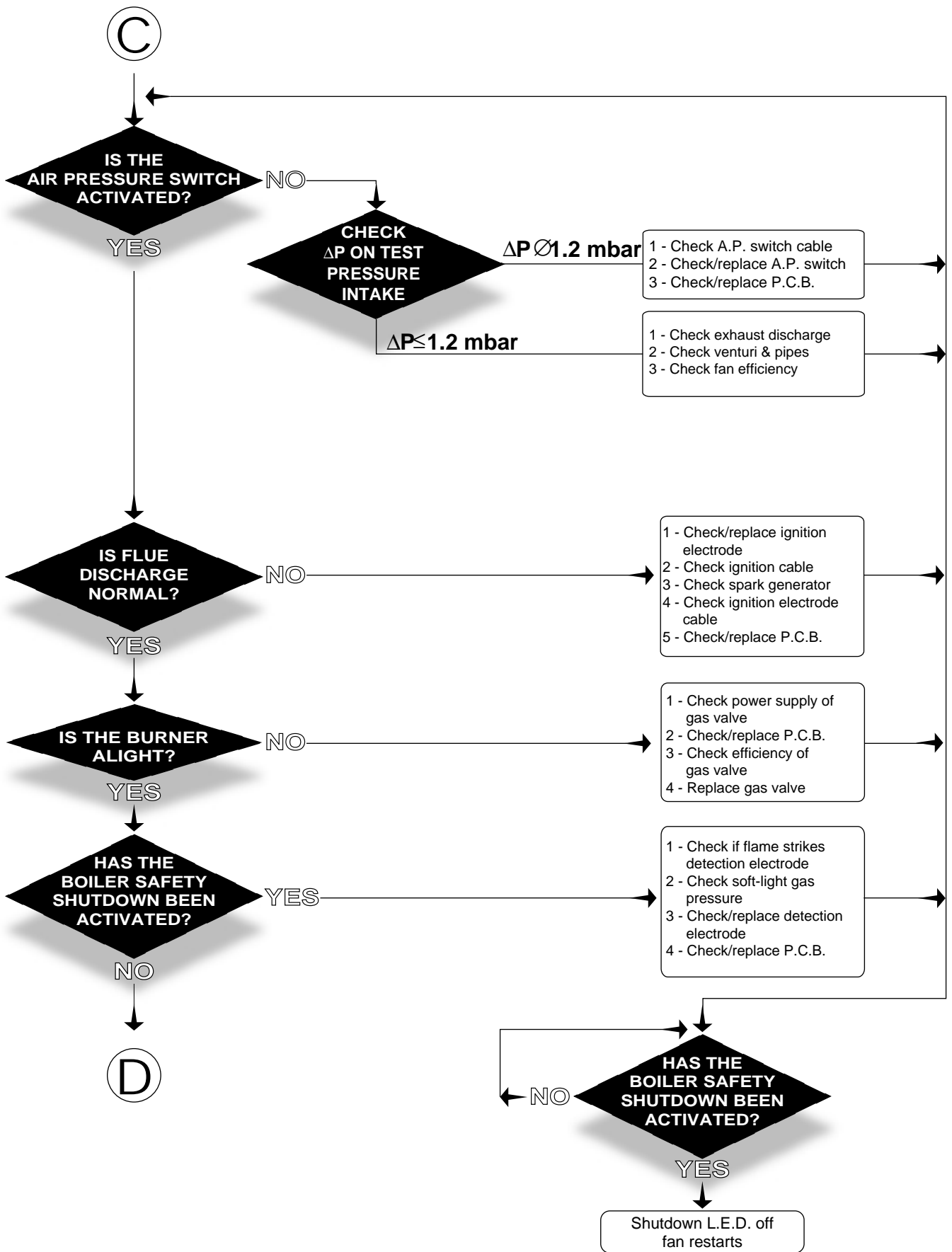

D

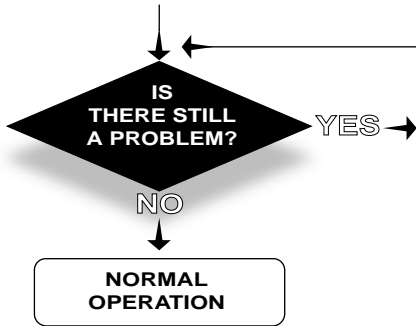

	<i>FAULTS</i>	<i>POSSIBLE CAUSES</i>
1	<b>Drawing D.H.W:</b> When you turn on a tap burner switches off	- air in secondary heat exchanger - faulty main circuit flow switch - faulty D.H.W. flow switch
2	<b>Drawing D.H.W:</b> radiators heat up in summer mode	- faulty 3-way valve
3	<b>Drawing D.H.W:</b> insufficient hot water temperature	- check C.H./D.H.W. temperature probes - check gas pressures - check water flow rate - check secondary heat exchanger
4	<b>Drawing D.H.W:</b> noisy operation	- primary heat exchanger faulty or lime-scale deposits - low heating system water pressure - check gas pressures - check C.H./D.H.W. temperature probes
5	<b>Decrease/increase</b> heating circuit pressure	- check for leaks on the heating circuit - faulty filling-loop - faulty secondary heat exchanger - expansion vessel faulty
6	<b>Repeated shutdowns</b>	- faulty detection electrodes - check gas settings - check flame detection electric circuit
7	<b>Repeated intervention of safety thermostat</b>	- C.H./D.H.W. temperature probes open circuit - overheat thermostat not calibrated correctly - air in primary water circuit
8	<b>When cold water tap turned off, the boiler ignites</b>	- drop in pressure in the water mains, with consequent water hammer
9	<b>Insufficient radiator temperature</b>	- check C.H. temperature probe - check by-pass - check gas pressures



### 3. **ELECTRICAL DIAGRAMS**

#### **LEGEND:**

A	=	Time Clock Connector
B	=	Central Heating Selection (Winter) and Temperature Adjustment
C	=	Connector for Total Check System
D	=	Domestic Hot Water Temperature Adjustment
E	=	Soft-light Adjustment
F	=	Maximum Heating Adjustment
G	=	On/Off Switch
H	=	On/Off L.E.D.
I	=	Fume Sensor L.E.D.
J	=	Ignition Failure (Lockout) L.E.D.
K	=	Low System Water Level/Lack of Circulation L.E.D.
L	=	Reset Button
M	=	Economy/Comfort Selector
N	=	Overheat L.E.D.
O	=	Temperature L.E.D.s
P	=	Transformer
Q	=	Circulation Pump Relay
R	=	Fan Relay
S	=	Gas Valve Relay
T	=	Motorised Diverter Valve Relay
V	=	Spark Generator
U	=	Anti-cycling Device Adjustment for Heating

A01	=	Circulation Pump
A02	=	Fan
A03	=	Spark Generator/Gas Valve Supply
A04	=	Motorised Diverter Valve
A05	=	Flame Detection Circuit
A06	=	Detection Electrode
A07	=	Main Circuit Temperature Probe
A08	=	Domestic Hot Water Temperature Probe
A09	=	Domestic Hot Water Flow Switch
A10	=	Main Circuit Flow Switch
A11	=	Modulator
A12	=	Air Pressure Switch
A13	=	Safety Thermostat
A14	=	External (Room) Thermostat

#### Colours:

Gry	=	Grey
Wh	=	White
Pnk	=	Pink
Brn	=	Brown
Bl	=	Blue
Blk	=	Black
Rd/Blk	=	Red/Black

# microGENUS 23/27 MFFI

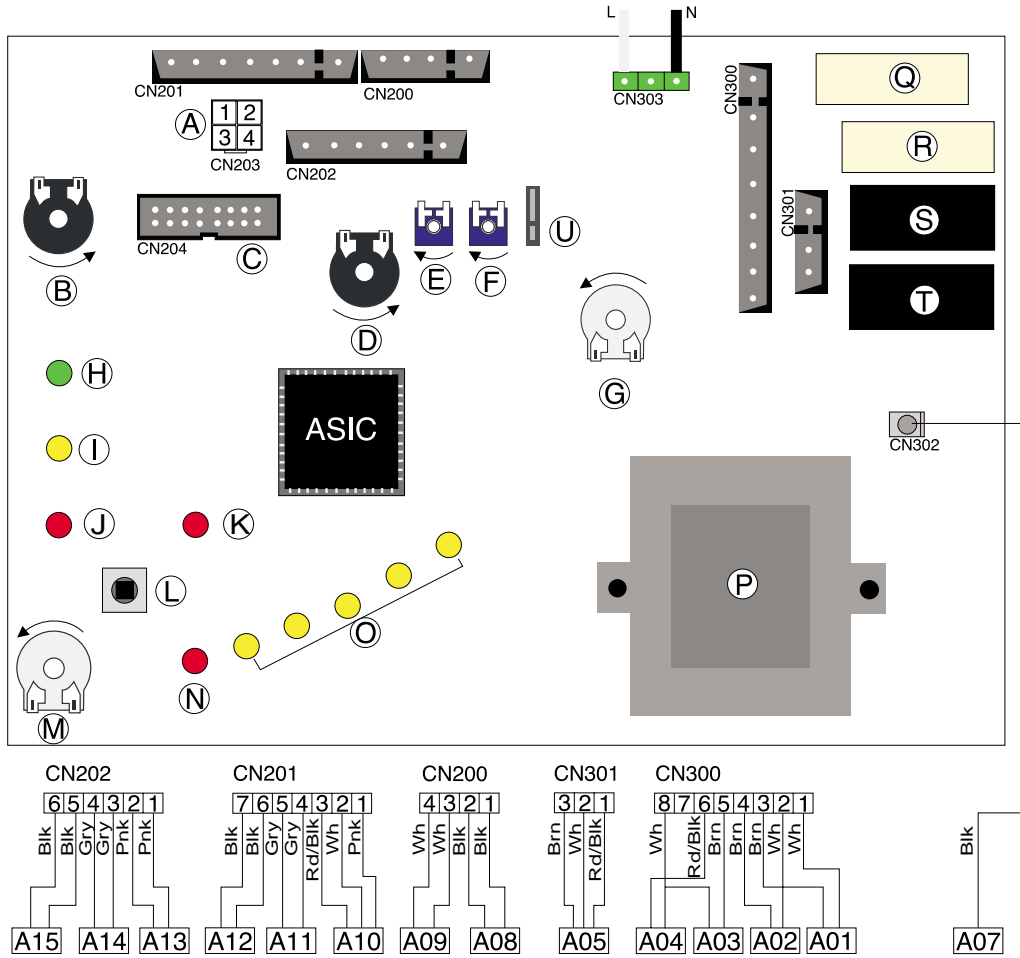

SE017A

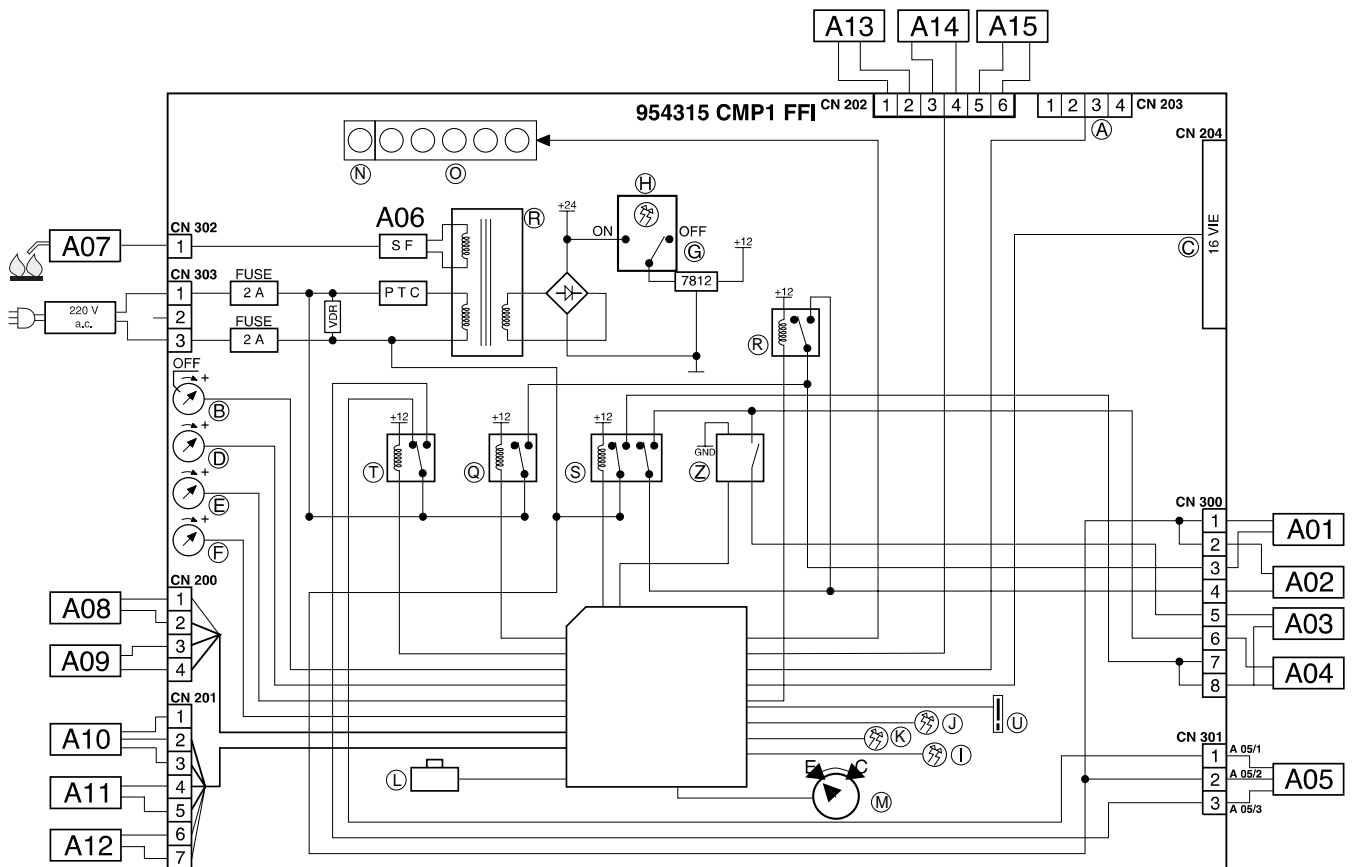

SF014A



# 4. SHORT SPARE PARTS LIST

## microGENUS 23/27 MFFI

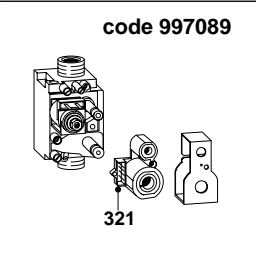
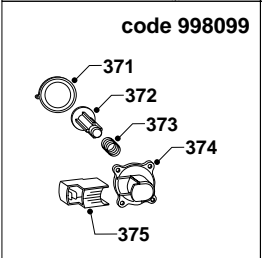
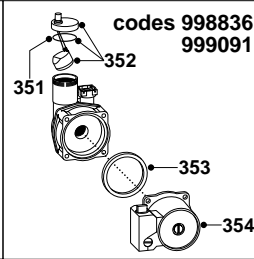
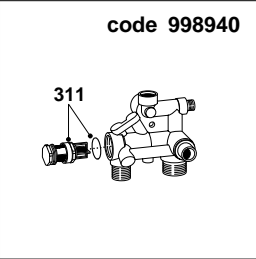
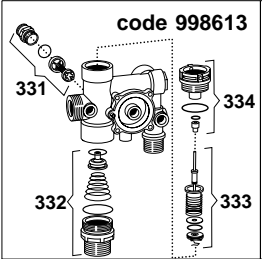
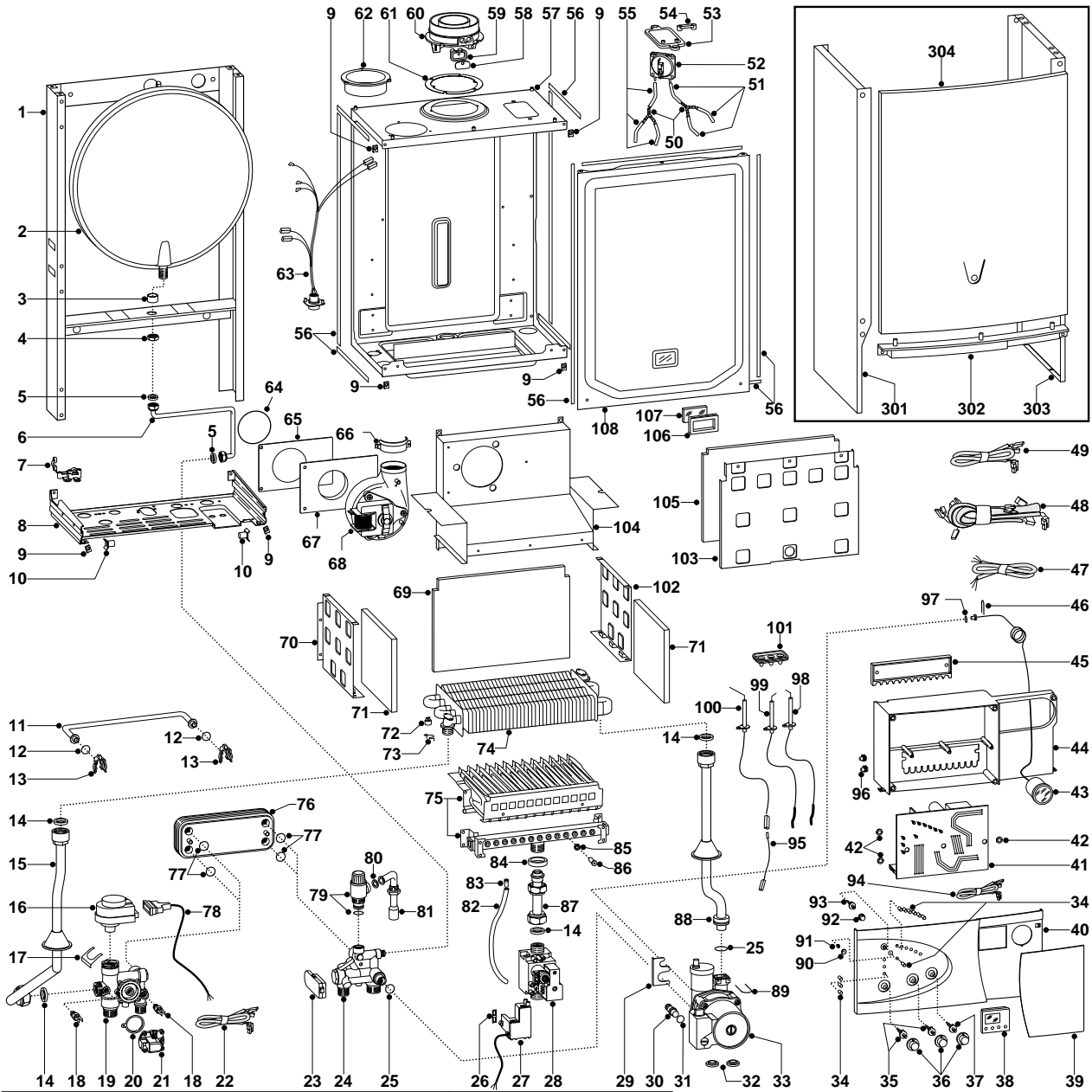

MODELS	CHARACTERISTICS	SERIAL NO: VALIDITY	REF.
MICROGENUS 23 MFFI	METHANE	2320005600001	A
MICROGENUS 23 MFFI	LPG	2320005600001	B
MICROGENUS 27 MFFI	METHANE	2320005600001	C
MICROGENUS 27 MFFI	LPG	2320005600001	D

**microGENUS 23/27 MFFI**

Key no.	G.C. part no.	Description	ARISTON Part No.
2	E61 468	Expansion vessel	998616
5	164 282	Gasket 3/8"	573521
12	E61 475	O-ring	998077
14	164 225	Gasket 3/4"	573520
16	E25 427	Motor (3- Way valve)	997147
17	E61 429	Fixing clip (motor)	997077
18	164 338	Temperature probe (C.H.W.)	569236
19	E61 478	Flow group	998613
20	E24 077	Diaphragm (main flow switch)	571547
21	E61 479	Main circuit flow switch	998099
24	E61 482	Return group	998940
25	E61 483	O-ring	998424
26	E25 529	Gasket	574279
27	E61 848	Spark generator	998645
28	E61 485	Gas valve (SIT 845 SIGMA)	997089
33 AB	E61 490	Pump	998836
33 CD	E61 881	Pump	999091
38		Time clock	999599
41	E61 519	P.C.B. (CMP1-FFI)	998947
43	E61 520	Pressure gauge	999245
52AB	E61 530	Air pressure switch	573989
52CD	E03 818	Air pressure switch	571651
66AB		Fan	999397
66CD	E61 967	Fan	998894
72	E25 425	Thermostat (overheat)	997206
74AB		Main exchanger	998620
74CD	E61 546	Main exchanger	998893
75A	E61 547	Burner 12 ramp (natural gas)	998618
75B	E61 549	Burner 12 ramp (LPG)	998669
75C	E61 972	Burner 14 ramp (natural gas)	998887
75D	E61 974	Burner 14 ramp (LPG)	998939
76AB	E26 767	Secondary exchanger (p-type 23kW)	571646
76CD	E26 657	Secondary exchanger (p-type 27kW)	573295
77	E26 658	O-ring (secondary exchanger)	573825
79	E26 378	Safety valve (1/2" 3 bar)	573172
98	E61 565	Electrode (Ignition R.H.)	998623
99	E61 567	Electrode (Ignition L.H.)	998622
100	E61 569	Detection electrode	998624
311		D.H.W. actuator kit	998941
321	E25 582	Operator coils (SIT SIGMA)	997029
331	E61 647	Central heating by-pass kit	998490
332	E61 648	Heating spring kit	998718
333	E61 649	3-way spring kit	998975
334	E61 650	Actuator bush	998974
351	E61 652	Gasket (auto air vent)	998644
352	E61 654	Auto air vent	998643
353	E61 656	Gasket (pump head)	998738
354 AB	E61 660	Pump head (Gold 15/5)	998961
354 CD	E62 030	Pump head	999207
371	E24 077	Diaphragm (main flow switch)	571547
372	E24 077	Magnet (main flow switch)	571772
373	E24 076	Spring (main flow switch)	571771
374	E24 075	Main flow switch top cap	571770
375	E61 663	Main flow switch reed system	998172
381	E61 665	Burner jet 1.25 full kit (Natural gas)	998716
382	E61 667	Burner jet 0.72 full kit (LPG)	998717



Manufacturer: **Merloni TermoSanitari SpA - Italy**

Commercial subsidiary: **MTS (GB) LIMITED**

MTS Building

Hughenden Avenue

High Wycombe

Bucks HP13 5FT

Telephone: (01494) 755600

Fax: (01494) 459775

internet: <http://www.mtsgb.ltd.uk>

E-mail: [info@mtsgb.ltd.uk](mailto:info@mtsgb.ltd.uk)

**Technical Service Hot Line: (01494) 539579**



SPARE PARTS EXPLODED VIEW  
GAS WALL BOILERS

Models

**MICROGENUS 27 MFFI**

---

Edition 2 of 1 February 2000



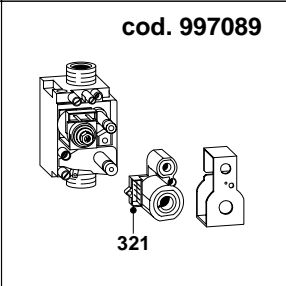
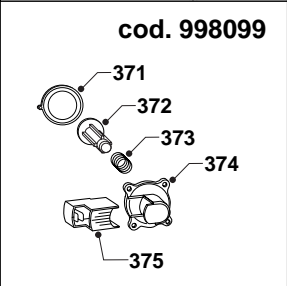
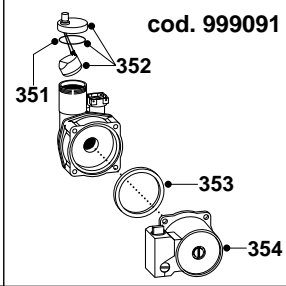
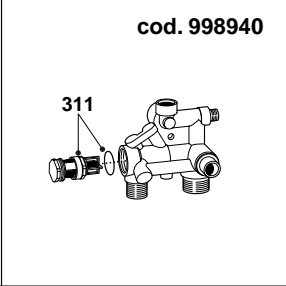
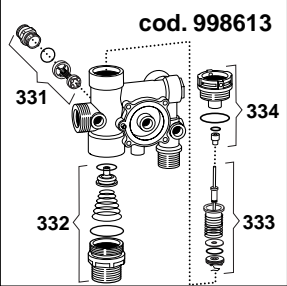
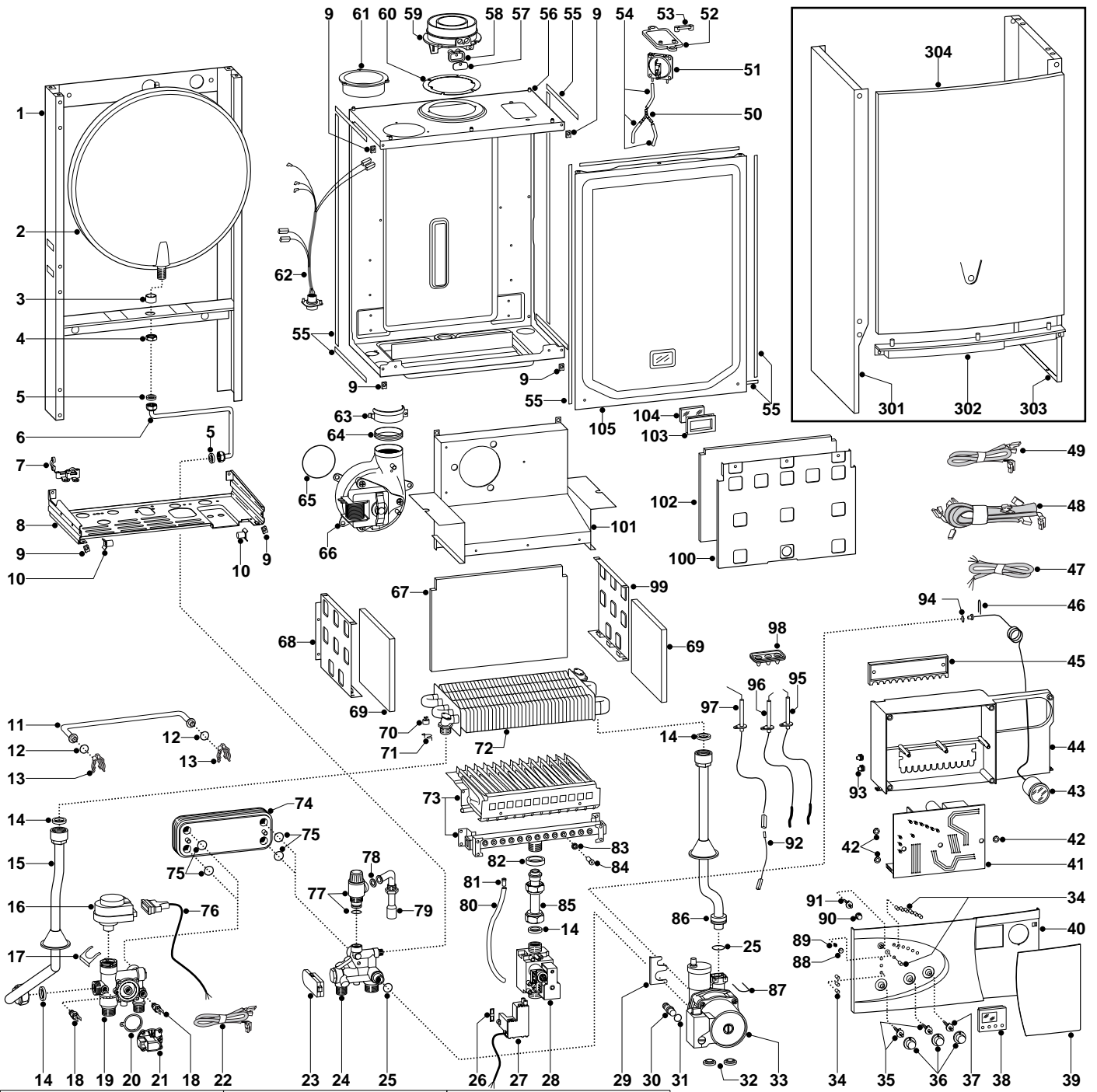

MODELS	CHARACTERISTICS	SERIAL NO: VALIDITY	REF.
MICROGENUS 27 MFFI	METHANE	0002601386	A
MICROGENUS 27 MFFI	LPG	0002601388	B

PART	CODE	DESCRIPTION	REF.	NOTE
1	-----	Frame		11
2	998616	Expansion vessel		
3	998776	Bush		
4	998581	3/8" lock nut		
5	573521	Gasket 3/8"		
6	999102	Pipe (expansion vessel)		
7	998580	Cable holder		
8	-----	Hydraulic group support		11
9	570717	Spring (fastening)		
10	998569	Pivot		
11	998589	By-pass pipe		
12	998077	O-ring gasket		
13	998064	Spring (by-pass pipe)		
14	573520	Gasket 3/4"		
15	999103	Pipe (flow)		
16	997147	Motor (3-Way valve)		
17	997077	Fixing clip (motor)		
18	569236	Temperature probe (C.H.W.)		
19	998613	Flow group		
20	571547	Diaphragm (main flow switch)		
21	998099	Main circuit flow switch		
22	998632	Cable (temperature probes)		
23	999075	D.H.W. flow switch		
24	998940	Return group		
25	998424	O-ring		
26	574279	Gasket		
27	998645	Spark generator		
28	997089	Gas valve (SIT 845 SIGMA)		
29	998606	Pump bracket		
30	998568	Pump plug		
31	997182	Gasket		
32	999100	Lock washer		
33	999091	Pump		
34	998570	L.E.D.		
35	998575	Spindle (temperature knob)		
36	998603	Control knob		
37	998572	Spindle (on/off knob)		
38	997207	Time clock		
39	999059	Front cover		
40	998824	Control panel		
41	998947	Printed circuit board (CMP1-FFI)		
42	569711	Nylon bush (10mm)		
43	998625	Pressure gauge		
44	998952	Control panel		
45	998953	Cable holder cover		
46	571548	Clip(Main Flow Switch)		
47	998861	Cable (power supply)		
48	999153	High voltage wiring		
49	998863	Low voltage wiring		
50	573327	Y piece (air pressure)		
51	571651	Air pressure switch		
52	997203	Support plate (Air pressure switch)		
53	573329	Pressure intake cover		
54	571575	Silicone pipe (positive signal)		
55	998516	Gasket (adhesive 10x6)		
56	-----	Sealed chamber		11
57	998565	Cover (flue test point)		
58	998636	Gasket (flue test point)		
59	998602	Flue (exhaust manifold/header)		
60	998637	Flange gasket		
61	998595	Plug (air intake)		
62	998648	Wiring loom (fan/air pressure switch)		
63	998566	Fixing clamp (fan)		
64	573446	Fan seal (silicone)		
65	998943	O-ring (2.65 x 101.27)		

PART	CODE	DESCRIPTION	REF.	NOTE
66	998894	Fan		
67	998896	Insulation panel (Rear)		
68	998964	Panel (combustion chamber - L.H. side)		
69	998639	Insulation panel (Side)		
70	997206	Thermostat (overheat)		
71	998583	Fixing spring (overheat thermostat)		
72	998893	Main exchanger		
73	998887	Burner 14 ramp (NG)	A	
73	998939	Burner 14 ramp (LPG)	B	
74	573295	Secondary exchanger (p-type 27kW)		
75	573825	O-Ring (secondary exchanger)		
76	998629	Cable (3-way valve motor)		
77	573172	Safety valve (1/2" 3 bar)		
78	573528	Gasket 1/2"		
79	998019	Pipe (safety valve outlet)		
80	573576	Compensation tube		
81	573325	Rivet		
82	569443	Silicone seal		
83	572138	Burner jet washer		
84	998433	Burner jet (NG 1.30)	A	
84	998434	Burner jet (LPG 0.77)	B	
85	998729	Pipe (gas valve)		
86	998732	Pipe (C.H. return)		
87	997153	U-clip		
88	998604	Reset button		
89	998571	Reset button (insert)		
90	999148	Selector button (comfort)		
91	998579	Spindle (comfort)		
92	998862	Cable (detection electrode)		
93	569720	Blind grommet		
94	998517	Gasket		
95	998623	Electrode (Ignition R.H.)		
96	998622	Electrode (Ignition L.H.)		
97	998624	Detection electrode		
98	998147	Ignition electrode cable rubber		
99	998963	Panel (combustion chamber - R.H.side)		
100	998924	Panel (combustion chamber front)		
101	998925	Flue hood		
102	998895	Insulation panel (Front)		
103	998076	View window glass gasket		
104	998075	View window glass		
105	998610	Panel (front - sealed chamber)		
301	998477	Case panel (L.H. side)		
302	998596	Insert (case)		
303	998476	Case panel (R.H. side)		
304	998607	Panel (front case)		
311	998941	D.H.W. actuator kit		
321	997029	Operator coils (Sit Sigma)		
331	998490	Central heating by-pass kit		
332	998718	3-Way spring kit (C.H.)		
333	998975	3-Way spring kit (D.H.W.)		
334	998974	Heating actuator bush		
351	998644	O-ring (A.A.V.)		
352	998643	Auto Air Vent		
353	998738	Gasket (pump head)		
354	999207	Pump head		
371	571547	Diaphragm (main flow switch)		
372	571772	Magnet (main flow switch)		
373	571771	Spring (main flow switch)		



<b>PART</b>	<b>CODE</b>	<b>DESCRIPTION</b>	<b>REF.</b>	<b>NOTE</b>
374	571770	Main flow switch top cap		
375	998172	Main flow switch reed system		
381	998716	Burner jet full kit (NG)		12
382	998717	Burner jet full kit (LPG)		12

<b>NOTE</b>	<b>DESCRIPTION</b>
11	Not supplied as a spare part
12	Not illustrated