

**WALL-MOUNTED GAS BOILERS**

**MVP**

**INSTRUCTIONS  
FOR FITTING AND  
MAINTENANCE**



**BIASI**  
U. K. LIMITED

## TECHNICAL SPECIFICATION

**Fan**, very quiet and efficient to safely discharge exhaust fumes.

**Flue hood**, made of aluminised sheet-metal and welded on the outer edges.

**Heat-exchanger** (primary) made of copper with brazed-on vanes and plated with tin-lead alloy against smoke corrosion.

**Modular burner**, made out of modular elements with stainless-steel heads.

**Combustion chamber**, dry-type, well-insulated and equipped with a pilot for ease of lighting (electric spark-pilot light) and function of the burner.

All the above parts are enclosed in an aluminised sheet-metal air-tight chamber with removable lid fitted with an inspection window.

**Gas supply unit**, includes a servo-assisted electric valve, which allows adjustment of central heating output independently of hot water supply (see table on page 14).

**Pump**, multi-speed, very quiet. Diagram 6 shows how to choose the speed most suitable for the system. For systems with a high-pressure gradient a higher pressure pump is available on request (diag. 7).

**Secondary water-water heat-exchanger**, consisting of a large surface area copper coil, which guarantees high performance for a long time even in hard-water areas.

**Three-way valve and differential pressure gauge**, to favour the hot water supply.

**Differential pressure gauge**, for the safe operation of the fan; it allows the main burner to ignite only if the air flow is sufficient for a correct combustion. Triple relay to check the pressure gauge-air cycle.

**Triple safety device**, against over-heating, both in the central heating and hot water systems.

**Security**, against failure of water supply or pump.

**Safety valve**, rated at 3 bar on the heating circuit.

**Automatic air vent**, ballcock type, plus manual vent on the secondary exchanger.

**Overflow tank**, closed type.

**Ignition**, electric.

**Temperature pressure gauge**.

**Thermostats**.

**Fitting template**, supplied with all boilers.

Gas and water **stopcocks** and filler tap.

**Cleaning attachments**, for the secondary heat-exchanger, fitted on the inlet and outlet pipes, allowing cleaning without dismantling.

**Robust frame** of aluminised black-painted sheet-metal, on which the air-tight chamber is welded.

Structurally compact external panelling which can be easily mounted and removed. The sheet-steel panels are specially treated by stove-enamelling.

**Parts supplied:** painted pipe joint, 1000mm painted pipe with outlet, washer, painted pipe cap.

The boiler is supplied with:

- **Timer clock** allowing the boiler to fire at pre-set times
- Isolating valves

On request the boiler, can be supplied with:

- **Pipe extensions.**

Diag. 1

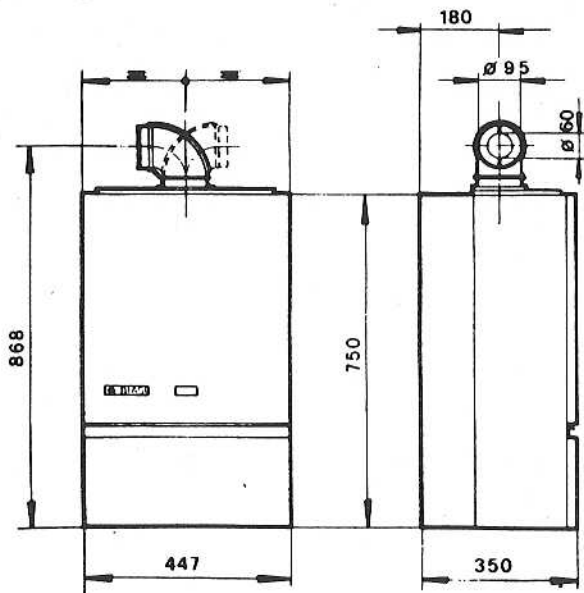

**OVERALL  
DIMENSIONS**

## INSTALLATION OF THE BOILER

The boiler is supplied with a sheet-metal **template** (diag. 2). By fixing the template to the wall, it will be possible to carry out all the operations which precede the installation of the boiler.

Sequence of operations:

- Fix the template to the wall so that it is perfectly vertical, using the four holes with diam. 9 and 5.

The **inserts** to be placed in the diam. 9 holes are to be used subsequently for mounting and fixing the boiler.

- Join the boiler to the water and gas pipes, fitting at the end of the pipes, suitable threaded stops or the taps supplied.
- Check that all systems are watertight, and leave under pressure until the boiler is mounted.

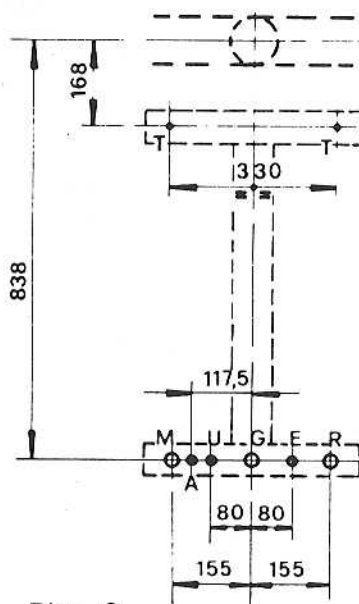

Diag. 2

### MOUNTING TEMPLATE

- M HEATING FLOW
- U DOMESTIC HOT WATER OUTLET
- G GAS INLET
- E COLD WATER INLET
- R HEATING RETURN

# CONNECTION LAYOUT

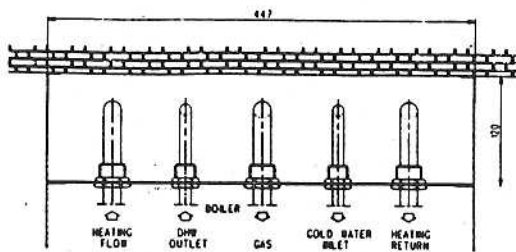

# CONNECTION SIZES

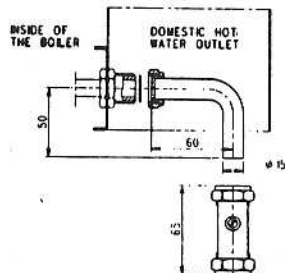
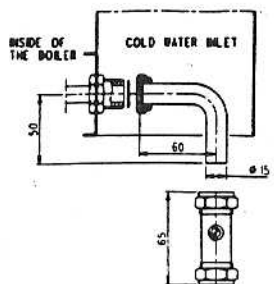
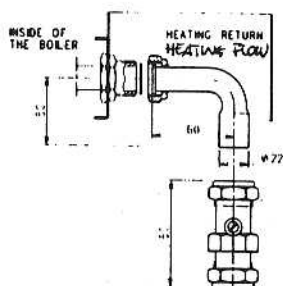
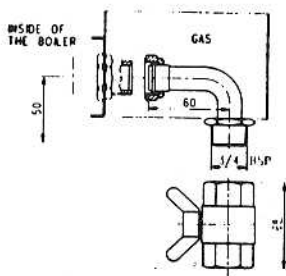

Diag. 3

- Installation of the flue pipe:
    - Diagram 4 shows the required measurements for the installation of a rear or lateral flue pipe.
- The flue pipe can rotate fully, thus allowing installation in any direction.
- For flue pipes longer than 1000mm (standard pipe supplied), 825mm long extension pipes are available to extend the flue up to 2725mm.
- To assemble the flue, proceed as follows:
- Drill a hole in the wall of 130 diam. in the position shown by diag. 4 with a 1% gradient.
  - Cut the pipes to the required length (see diag. 5).
  - Remove the same length of pipe from the untapered end of both pipes.
  - Insert the hole drilled previously the concentric pipe with the external cap and gasket already assembled (item 7 diag. 5).
- Install the boiler, joining the various ends to the **pipes already fitted**, according to the instructions on diag. 3.

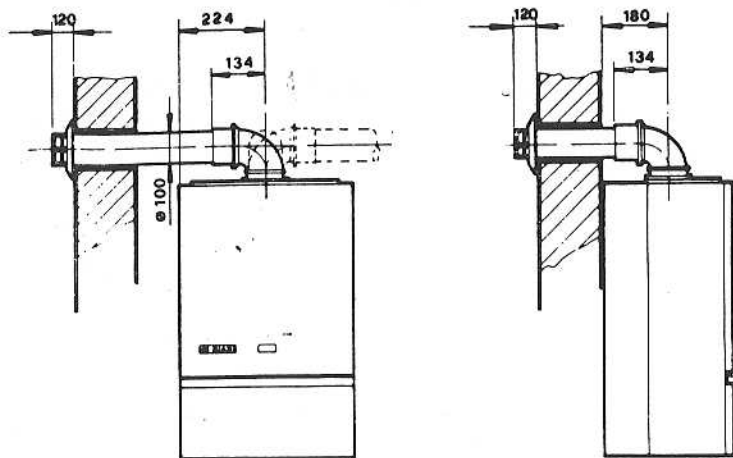

Diag. 4

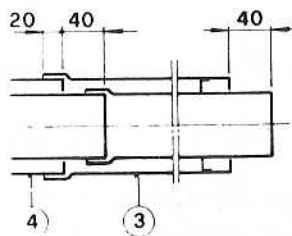

Detail X

Extension pipe joint

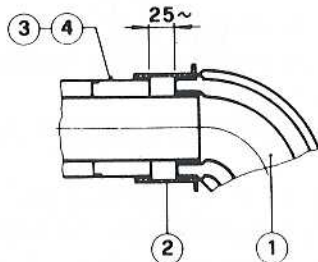

Detail Z

Pipe bend joint

Flue pipe  
(pipe joint diam.  
100)

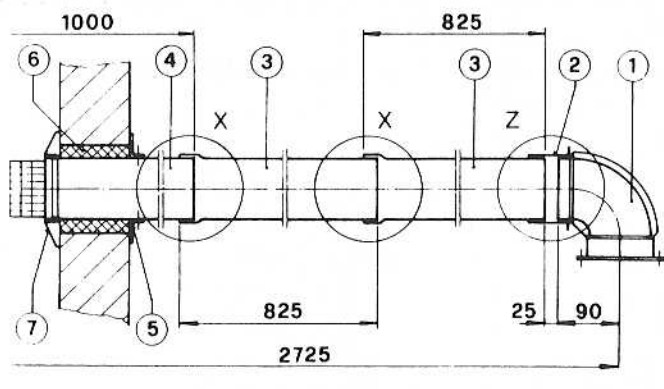

- Item 1 Boiler pipe bend joint
- 2 Silicon rubber seal joint
- 3 Extension pipe (o
- 4 End pipe with diffuser
- 5 Bracket with retain screws
- 6 Removable filling material
- 7 Silicon rubber gasket

Diag. 5

- Fit an **electric switch** (240V/6A) near the boiler and an **earthed electric socket**.

Fit the electrical wiring according to the diag. on page 16 and inside the instrument panel.

- Slowly let water into the system through the **filler tap**, located at the bottom of the boiler. Adjust the pressure to approximately **1.2 bar**, carefully allowing all the air to escape through the **automatic bleed cap**, which must always be left open, the pump cap and the manual valve located on the secondary exchanger.
- Check all water and gas joints for tightness.

# PUMP SPECIFICATION

The effective pressure in the system is the difference between the pressure at the pump and the pressure drop in the boiler (dotted curves at various flow-rates).

- It is possible to select different modes of function when installing:
- Constant pump operation;
- Pump stops when either the boiler or the room thermostats switch off. See the wiring diagram on page. 16.

Diagram 6 - Standard pump

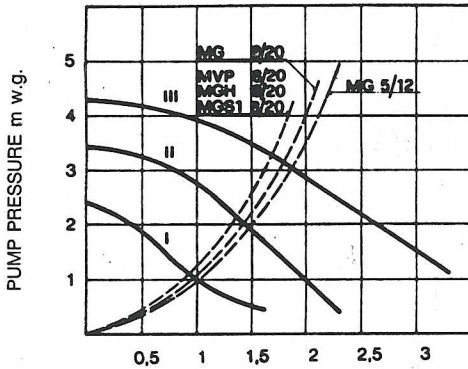
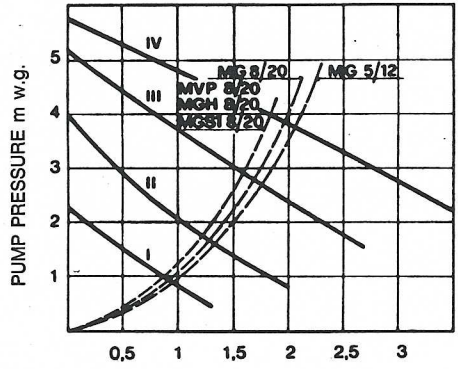

Diagram 7 - High pressure pump (optional)



Flow-rate m3/h

## SET UP

Preliminary operations:

- Turn on **taps** 29, 31, 32, 33 (diag. 8).
- Ensure that the heating system is full of water, checking on the **pressure gauge** that the cold water pressure is approximately **1.2 bar**. If the pressure is lower, increase it by turning on the cold water inlet tap which can be found at the bottom of the boiler, not forgetting to turn it off carefully, once the correct pressure has been reached. Repeat this procedure whenever necessary. When the boiler is working properly, the hot water pressure should not exceed 2.2. bar.
- Ensure that the boiler is wired to the correct electrical supply (**240 V**) and that it is **earthed**, according to E.E.C. and local regulations.



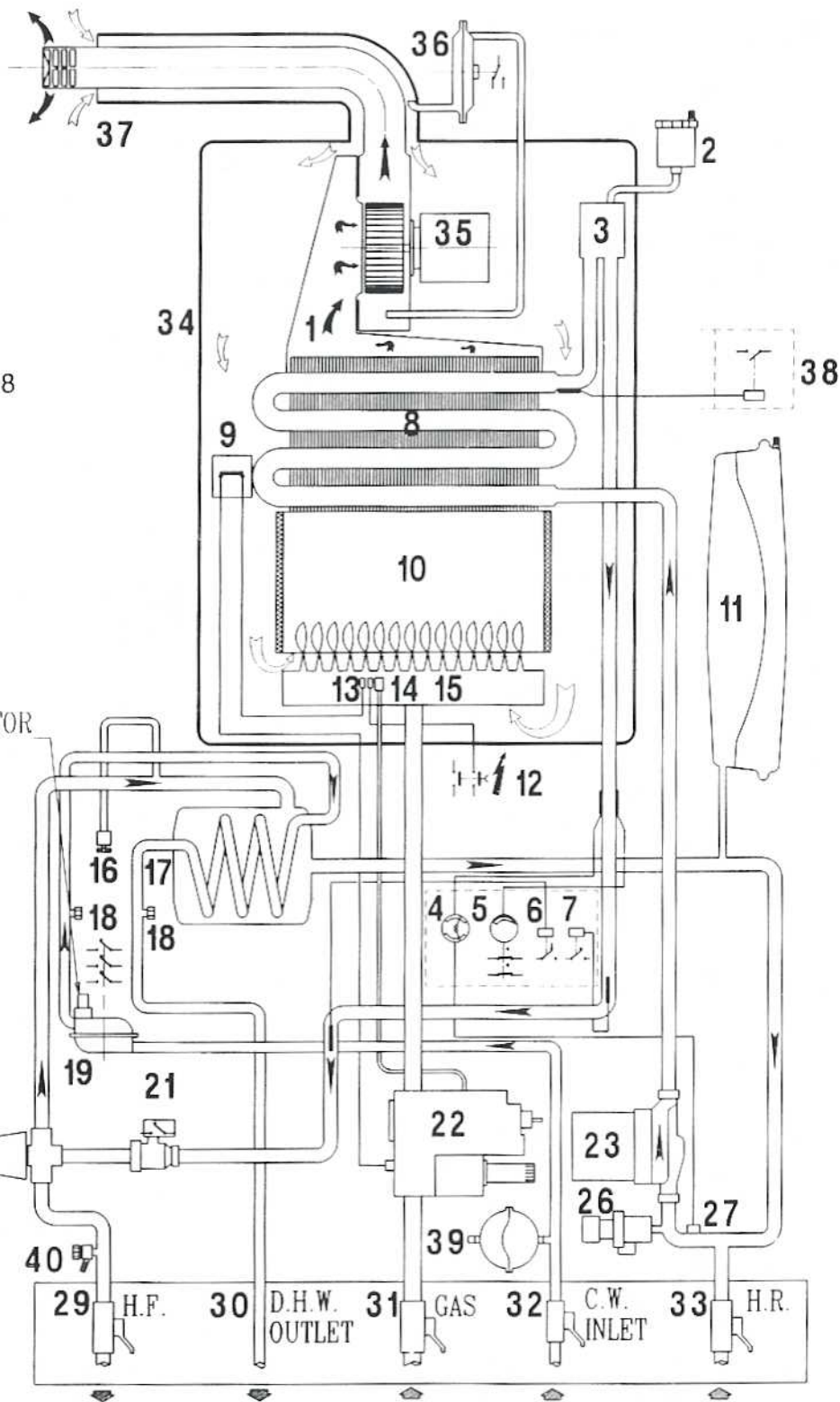

Diag. 8

RESTRICTOR  
SCREW

## KEY

- |    |                                     |    |  |
|----|-------------------------------------|----|--|
| 1  | Flue Hood                           | 20 | Three-way Electric Diverting Valve         |
| 2  | Automatic Air Vent                  | 21 | Heating Flow Switch                        |
| 3  | Air Separator                       | 22 | Gas Valve                                  |
| 4  | Temperature / Pressure Gauge        | 23 | Pump                                       |
| 5  | Heating Thermostat                  | 26 | Safety Valve                               |
| 6  | Limit Thermostat                    | 27 | Pressure Gauge Attachment                  |
| 7  | Domestic Hot Water Thermostat       | 28 | Assembly Template                          |
| 8  | Main Heat Exchanger                 | 29 | Heating Flow (Isolating Valves Supplied)   |
| 9  | Safety Thermostat                   | 30 | D.H.W. Outlet                              |
| 10 | Combustion Chamber                  | 31 | Gas Inlet (Tap Supplied)                   |
| 11 | Expansion Tank                      | 32 | Cold Water Inlet                           |
| 12 | Electric Ignition                   | 33 | Heating Return (Isolating Valves Supplied) |
| 13 | Thermocouple                        | 34 | Sealed Chamber                             |
| 14 | Pilot Burner                        | 35 | Fan  |
| 15 | Main Burner                         | 36 | Air Differential Pressure Switch           |
| 16 | Manual Air Vent                     | 37 | Flue Pipe                                  |
| 17 | Secondary Heat Exchanger            | 38 | Pump Thermostat                            |
| 18 | Chemical Wash Attachment            | 40 | Drain Cock                                 |
| 19 | D.H.W. Differential Pressure Switch |    |  |

# IGNITION

- Turn the **mains switch** on (red pilot light on).
- Push the **gas valve button** right in (item 6 in diagram 9) and keep it pressed until the pilot is lit Approx. 20 seconds).
- Keep the **gas valve button** pressed home for another 15 to 20 seconds.
- Release the **gas valve button** ensuring that the pilot stays lit, otherwise repeat the above steps.

Bear in mind that lighting the pilot may be difficult the first time because the gas pipe is full of air which must be expelled.

**GAS VALVE (Diag. 9)**

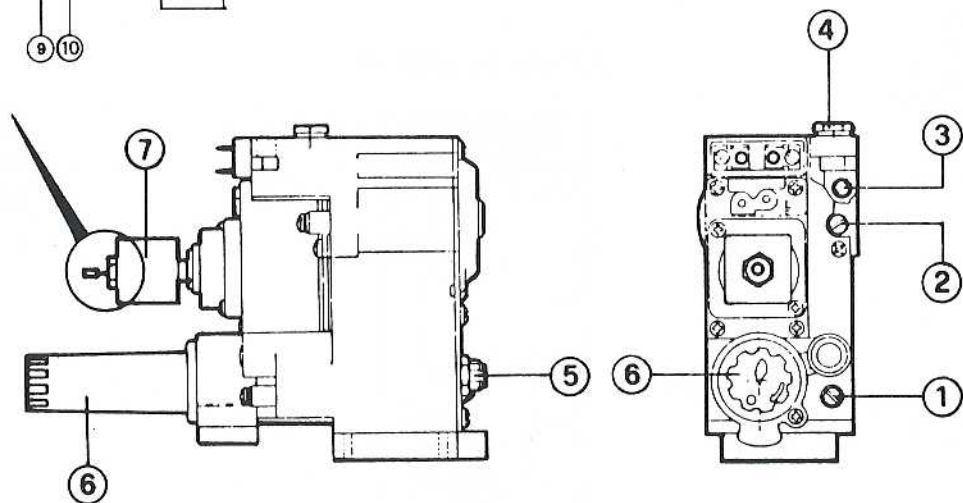
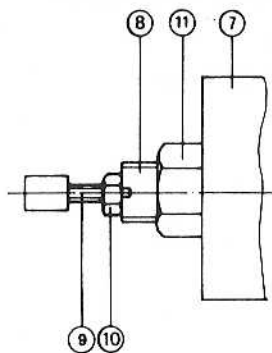

- 1) Valve inlet pressure attachment
- 2) Valve outlet pressure attachment
- 3) Pilot light adjuster
- 4) Pilot tube connector
- 5) Thermocouple connector
- 6) Gas button

- 7) Solenoid
- 8) Max Gas Rate (D.H.W.) Adjustment Screw
- 9) Min Gas Rate (C.H.) Adjustment Screw
- 10) C.H. Adjustment Locknut
- 11) D.H.W. Adjustment Locknut

## ADJUSTING THE OUTPUT OF THE BOILER

The following procedure must be carried out only by personnel authorised by BIASI U.K.

### FAN

Make the circuit according to the length of the flue pipe (see wiring diagram on page 16):

- from 0 to 1 m make the connection with terminal 1 (link III)
- from 1 to 2 m make the connection with terminal 2 (link III)
- from 2 to 2.75 m make the connection with terminal 3 (link III)

If additional pipe bends are required, contact the Biasi U.K. after sale service.

Checking that the calibration of the gas pressure gauge is correct when running:

### HOT WATER (CALIBRATED IN THE FACTORY)

- Connect a U-shaped pressure gauge to the gas valve outlet pressure attachment, diag. 9 item 2, after underscrewing the internal capping screw. (Remember to tighten it carefully once the procedure has been completed).
- Turn on one hot water tap and check that:
  - the burner lights at an output of 2-3 litres per minute;
  - the gas pressure at the U-shaped pressure gauge registers the maximum value given in the table on page 14 at outputs above 13 litres per minute. If the value is different, adjust the **maximum pressure control** on the solenoid, items 8-11 in diagram 9.

After this procedure it is also necessary to recalibrate the minimum pressure value (items 9-10, diag. 9).

### HEATING

- Set the **winter/summer switch** to the **winter position (snow symbol)**.
- Turn the **boiler thermostat and room thermostat** (if fitted) to their highest settings.
- The boiler will light at an output preset in the factory (approximately 60% of the maximum level).

To operate the boiler at outputs lower or higher than preset values proceed as follows:

- Turn the **mains switch off**.

- Connect a **U-shaped pressure gauge** to the **outlet pressure gas valve** (diagram 9 item 2) as described to check the hot water pressure.
- **Switch the mains back on.**
- Set the **power adjustment potentiometer** (diagram 10) to a value equal to or just higher than the desired thermal output, according to the table. To facilitate this procedure, begin within the highest pressure and come down to the chosen value.
- Check this setting by turning the knob of the boiler thermostat, thus turning the boiler on and off at least twice.

### POWER ADJUSTER

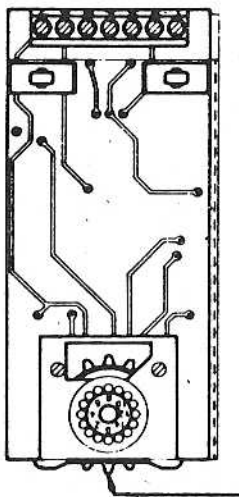

(Diag. 10)

POTENTIOMETER

## OPERATION

### Heating and hot water

- Set the **winter/summer switch to winter position (snow symbol)**.
- Temperature setting:  
If the system is not fitted with a room thermostat, the temperature of the water circulating in the radiators must be adjusted by turning the boiler **thermostat knob**.  
The **burner** automatically keeps the pre-set temperature in the radiators constant.  
If the system is fitted with a **room thermostat**, set the **boiler thermostat** at its maximum temperature: the boiler will work according to the temperature shown by the **room thermostat**.  
When a hot water tap is turned on, the boiler will deliver the output necessary to keep the water temperature constant.

### Hot water only

- Set the **winter/summer switch** to the summer position (**sun symbol**). On this setting the boiler only delivers hot water.
- Turn on a hot water tap to get a flow rate of 2 - 3 l/m and check that the boiler lights up.

### Setting the D.H.W. Flow Rate

A restrictor screw (Diag. 11) is fitted to adjust the D.H.W. flow to that which will give an acceptable D.H.W. temperature. To set D.H.W. flow, procede as follows:

- Select Summer position on the Summer/Winter switch.
- Fully open the D.H.W. tap furthest away from the boiler.
- Check that boiler is firing at maximum burner pressure.
- Adjust the D.H.W. flow-rate by turning the restrictor screw on the D.H.W. differential pressure PDS until a satisfactory D.H.W. temperature rise is achieved.
- Turn off the tap.

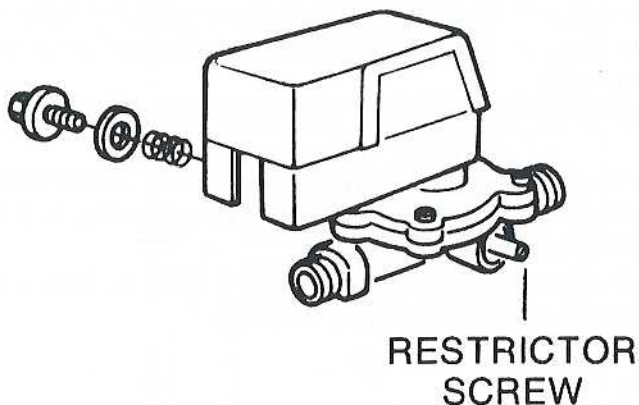

Diagr. 11

## TIMER CLOCK

In boilers fitted with a **timer clock**, it is possible to operate the **central heating system** at preset times only.

To set these times, turn the timer knob in the direction of the arrow to the correct time of day, then position the selectors on the outer ring of the timer to correspond with the chosen times.

Delivery of hot water only is always possible, even when the **timer** switches off the central heating.

## SWITCHING OFF THE SYSTEM

- Turn the **gas valve: button** (diag. 9 item 6) clockwise by 45° to turn off the gas supply.
- Turn the **mains switch** off (red light off).
- When switching the boiler off for a long time, turn the mains gas and electricity supply off.

# TECHNICAL DATA REGULATION AND GAS CONSUMPTION MVP

GAS		NET CALORIFIC VALVE 1013 mbar, 15° C MJ/m <sup>3</sup>		INLET PRESSURE mbar		Ø NOZZLE mm/100				N.	
						PILOT		BURNER			
METHANE NG		34.02		15÷23		27		125		13	
BUTHANE LPG		116.46		25÷35		22		75		13	
HEAT INPUT		HEAT OUTPUT		NOZZLE PRESSURE				GAS RATE			
kW	Btu/h	kW	Btu/h	NG		LPG		NG		LPG	
				mbar	in.w.g.	mbar	in.w.g.	m <sup>3</sup> /h	ft <sup>3</sup> /h	kg/h	lb <sup>3</sup> /h
11.7	39.900	9.3	31.700	1.0	0.4	4.4	1.76	1.20	42.3	0.89	1.96
14.3	48.760	11.6	39.600	2.2	0.86	6.7	2.68	1.48	52.2	1.10	2.42
16.8	57.290	13.9	47.400	3.4	1.33	9.4	3.76	1.75	61.7	1.31	2.89
19.2	65.470	16.3	55.600	4.8	1.89	12.4	5.0	2.02	71.2	1.51	3.33
21.6	73.660	18.6	63.500	6.5	2.70	15.8	6.3	2.29	80.7	1.70	3.74
24.0	81.850	20.9	71.300	8.4	3.30	19.7	7.9	2.55	89.8	1.90	4.19
25.8	88.000	23.3	79.500	10.3	4.05	24.0	9.6	2.74	98.3	2.08	4.58

The consumption shown in the table refers to the net calorific value of the gases at a temperature of 15°C and a nozzle pressure (1013+pu) /1013





240 V-50 Hz

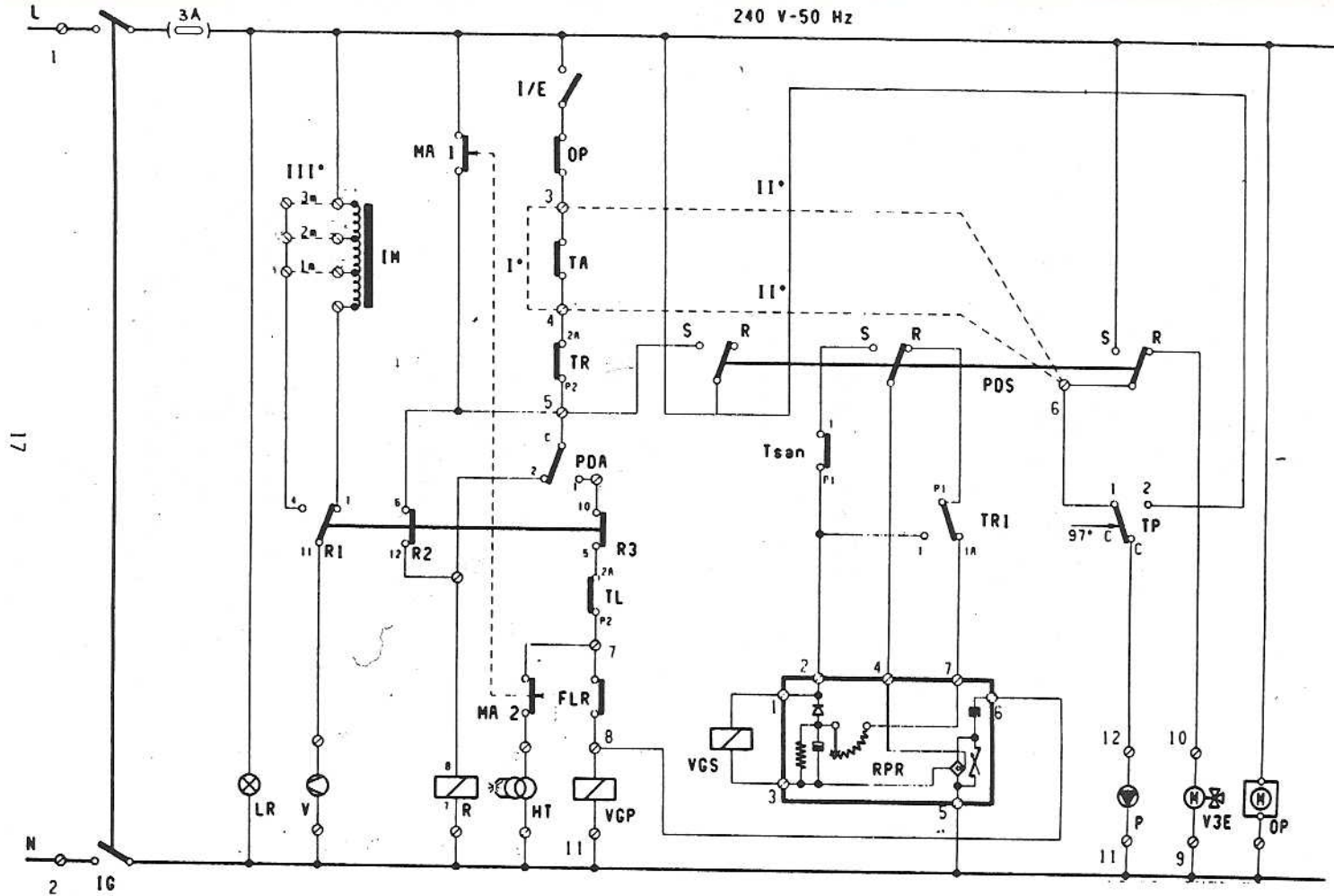

## KEY

IG	Main Switch	V	Fan
IE	Summer/Winter Switch	R	Auxiliary Relay for PDA
OP	Timer Clock	HT	Electric Ignition
TA	Room Thermostat	VGP	Main Gas Valve
TR	Heating Thermostat	RPR	Heating Output adjuster
TRI	Heating Low Flame Thermostat	VGS	Secondary Gas Valve
TL	Limit Thermostat	P	Pump
TSan	Domestic Hot Water Thermostat	LR	Wiring Light
IM	Fan Impedence	MA1	Ignition Microswitch
PDA	Air Differential Pressure Switch	MA2	Ignition Microswitch
PDS	D.H.W. Differential Pressure Switch	V3E	Three-way Electric Diverting Valve
FLR	Heating Flow Switch	TP	Pump Thermostat

## SUITABILITY FOR OTHER GASES

Our factory-produced boilers can be adapted for other gases. **Such procedures must be carried out by personnel authorised by Biasi U.K.**

## YEARLY MAINTENANCE

**To be carried out by authorised personnel.**

- Clean the flue.
- Clean the burner and the primary exchanger.
- Test the checking and safety devices (pressure gauge, thermostats, safety valve and various sensors).
- Optional chemical wash of the hot water system secondary exchanger.

## WARNING

All boiler installations must be carried out by C.O.R.G.I. approved installers and according to the current regulations governing electrical and gas supply and flue. Also ensure that the room where the boiler is to be installed is suitable. **Biasi U.K. disclaims all liability for accidents caused by breach of such regulations, or in circumstances where the instructions contained in this manual have not been followed.**

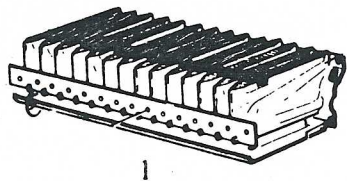

1



2



3



4



5



6

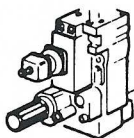

7

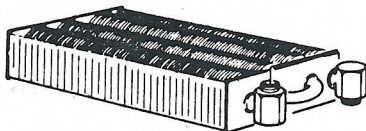

8



9



10



11



12



13

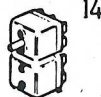

14

29



15



16



17

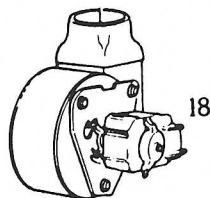

18

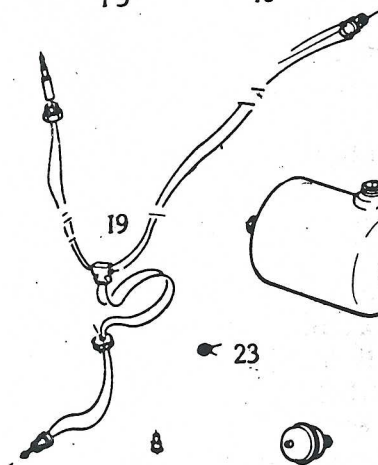

19

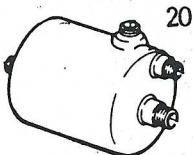

20

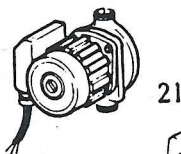

21

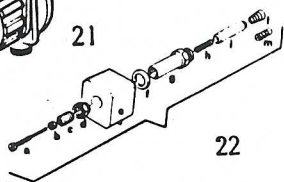

22



23



24



25



26



27

## REPLACEMENT PARTS

KEY	CODE	DESCRIPTION
1	F36010	MAIN BURNER
2	F07105	PILOT BURNER
3	F21105	SAFETY VALVE
4	F06010	ELECTRIC IGNITION
5	F07010	ELECTRODE
6	F24206	TRHEE-WAY ELECTRIC DIVERTING VALVE
7	F22026	GAS VALVE
8	F90001	HEAT EXCHANGER
9	F41030	PUMP THERMOSTAT
10	F40010	TEMPERATURE/PRESSURE GAUGE
11	F02050	MAIN SWITCH
12	F02060	IGNITION MICROSWITCH
13	F06040	HEATING OUTPUT ADJUSTER RPR
14	F41012	HEATING THERMOSTAT 30/85 °C
15	F41027	DHW DIFFERENTIAL PRESSURE SWITCH
16	F41028	AIR DIFFERENTIAL PRESSURE SWITCH
17	F08015	FAN IMPEDENCE
18	F32020	FAN
19	F07020	THERMOCOUPLE INTERRUPTION CABLE L 500
20	F90014	DHW HEAT EXCHANGER
21	F30058	PUMP
21	F30100	HIGH PRESSURE PUMP
22	F08032	SECONDARY GAS VALVE
23	F07100	MAIN INJECTOR NG
23	F07012	MAIN INJECTOR LPG
24	F07054	PILOT INJECTOR NG
24	F07052	PILOT INJECTOR LPG
25	F90020	DHW EXPANSION VESSEL
26	F90016	HEATING EXPANSION VESSEL
27	F41102	HEATING FLOW SWITCH
28	F02020	SUMMER/WINTER SWITCH
29	F41010	LIMIT THERMOSTAT 80/88 °C